

To:

CIVA President

### **Free Known Analysis of Figure Proposals Received for 2018**

On the following pages are proposals I have received to date for the Free Known figures for power competitions in 2018.

Having consulted colleagues on the KAWG, I have the following comments.

#### **Unlimited**

U1 - figure 3 GLOC potential. Not recommended.

U2 - perhaps too high on total K. High speed neg snap on figure 2. Not recommended.

U3 - no issues, reasonable total K. **Recommended.**

U4 - reasonable total K. High speed snap followed by climbing roll on figure 5. Potential to damage aeroplane. Not recommended.

#### **Advanced**

A1 - medium total K, no significant issues. **Recommended.**

A2 - low-medium K, potential GLOC on figure 4. Not recommended.

A3 - high total K. Complex slide. Risky high speed pos snap on figure 4. Not recommended.

A4 - medium total K, no significant issues. **Recommended.**

A5 - low total K. Not recommended.

A6 - figure 2 GLOC potential. Not recommended.

#### **Intermediate**

I1 - reasonable total K, no significant issues. **Recommended.**

I2 - reasonable total K, figure 3 has flick and spin; perhaps too dominating. **2nd choice.**

I3 - low total K. Lacks demand. Not recommended.

Thanks

Alan Cassidy  
KAWG  
4 October 2017

Copy to:  
KAWG members

# Proposals Unlimited 2018

## U1 - 197K

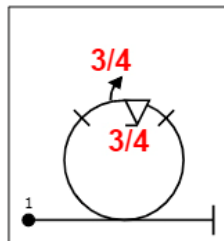
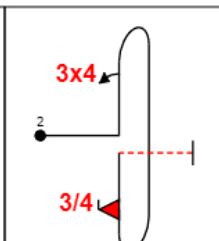
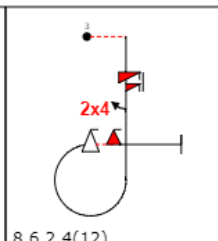
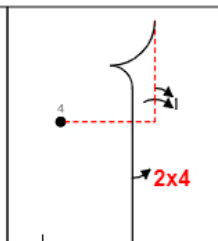
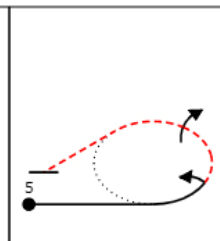
 <p>7.4.1.1(10) 9.9.3.3(11) 9.1.3.3(6) <b>K: 27</b></p>	 <p>8.8.1.1(18) 9.4.1.3(12) 9.10.6.3(19) <b>K: 49</b></p>	 <p>8.6.2.4(12) 9.12.1.6(5) 9.4.5.2(5) 9.9.3.4(11) 9.10.3.2(13) <b>K: 46</b></p>	 <p>6.2.1.4(17) 9.1.1.6(15) 9.4.5.2(5) <b>K: 37</b></p>	 <p>2.3.6.1(38) <b>K: 38</b></p>
------------------------------------------------------------------------------------------------------------------------------------------------------	--------------------------------------------------------------------------------------------------------------------------------------------------------	---------------------------------------------------------------------------------------------------------------------------------------------------------------------------------------	-------------------------------------------------------------------------------------------------------------------------------------------------------	-------------------------------------------------------------------------------------------------------------------------

## U2 - 269K

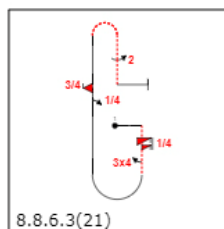
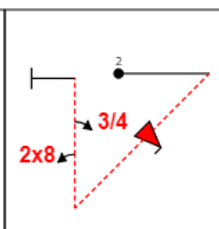
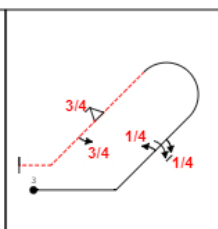
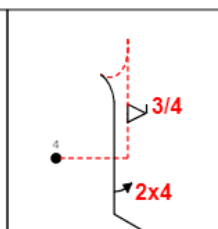
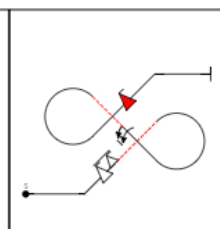
 <p>8.8.6.3(21) 9.12.1.5(6) 9.4.5.3(8) 9.1.1.1(6) 9.10.1.3(17) 9.2.5.4(9) <b>K: 67</b></p>	 <p>1.2.9.3(20) 9.10.4.4(13) 9.8.1.1(7) 9.1.1.3(10) <b>K: 50</b></p>	 <p>8.4.13.1(11) 9.1.2.1(4) 9.1.2.5(11) 9.9.9.3(13) 9.1.4.3(6) <b>K: 45</b></p>	 <p>6.2.2.4(17) 9.9.6.3(17) 9.4.5.2(5) <b>K: 39</b></p>	 <p>7.8.13.1(23) 9.9.2.6(16) 9.1.2.6(12) 9.10.7.4(17) <b>K: 68</b></p>
-----------------------------------------------------------------------------------------------------------------------------------------------------------------------------------------------------	-----------------------------------------------------------------------------------------------------------------------------------------------------------------------	--------------------------------------------------------------------------------------------------------------------------------------------------------------------------------------	-------------------------------------------------------------------------------------------------------------------------------------------------------	---------------------------------------------------------------------------------------------------------------------------------------------------------------------------

## U3 - 208K

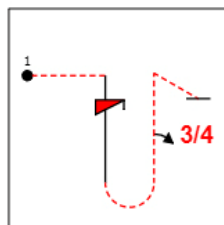
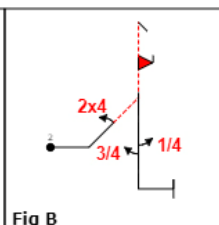
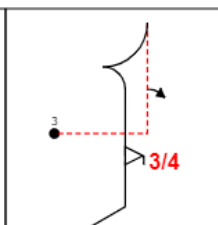
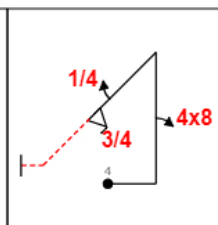
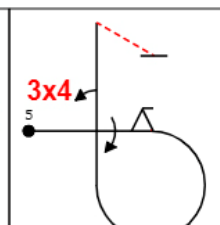
 <p><b>Fig A</b> 8.4.3.4(16) 9.12.1.4(7) 9.1.1.3(10) <b>K: 33</b></p>	 <p><b>Fig B</b> 5.3.2.1(24) 9.4.2.2(7) 9.10.1.2(17) 9.1.5.1(2) 9.1.5.3(6) <b>K: 56</b></p>	 <p><b>Fig C</b> 6.2.1.4(17) 9.1.1.2(8) 9.9.5.3(11) <b>K: 36</b></p>	 <p><b>Fig D</b> 1.2.8.1(16) 9.8.1.2(11) 9.1.4.1(2) 9.9.4.3(11) <b>K: 40</b></p>	 <p>8.6.7.3(12) 9.1.3.4(8) 9.9.3.2(11) 9.4.1.3(12) <b>K: 43</b></p>
--------------------------------------------------------------------------------------------------------------------------------------------------------------------------	--------------------------------------------------------------------------------------------------------------------------------------------------------------------------------------------------------	-------------------------------------------------------------------------------------------------------------------------------------------------------------------------	------------------------------------------------------------------------------------------------------------------------------------------------------------------------------------------	--------------------------------------------------------------------------------------------------------------------------------------------------------------------------

## U4 - 207K next page

4 submissions

Unlimited FreeKnown

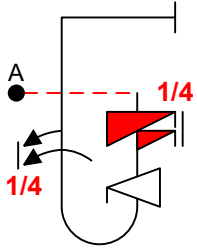
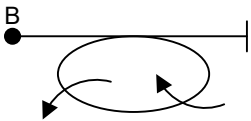
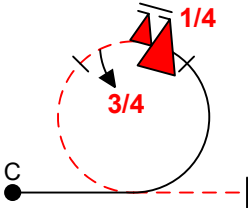
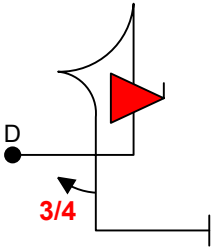
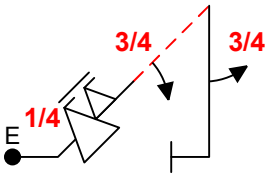
Max Fig K No Limit	1A		8.4.2.4 14 9.12.1.5 6 9.9.5.4 11 9.1.1.5 14	6F	<input type="checkbox"/>
Min Fig K 0					
Total Fig K 207					<input type="checkbox"/>
Positioning	2B		2.4.4.1 46	7G	<input type="checkbox"/>
40					
Harmony					
					<input type="checkbox"/>
	3C		7.4.2.1 12 9.10.8.5 17 9.1.3.3 6	8H	<input type="checkbox"/>
					<input type="checkbox"/>
	4D		6.2.1.1 15 9.10.6.4 19 9.1.5.3 6	9I	<input type="checkbox"/>
					<input type="checkbox"/>
	5E		1.2.3.1 12 9.9.2.5 15 9.1.2.3 8 9.1.5.3 6	10J	<input type="checkbox"/>
					<input type="checkbox"/>

# Proposals Advanced 2018

## A1 - 160K

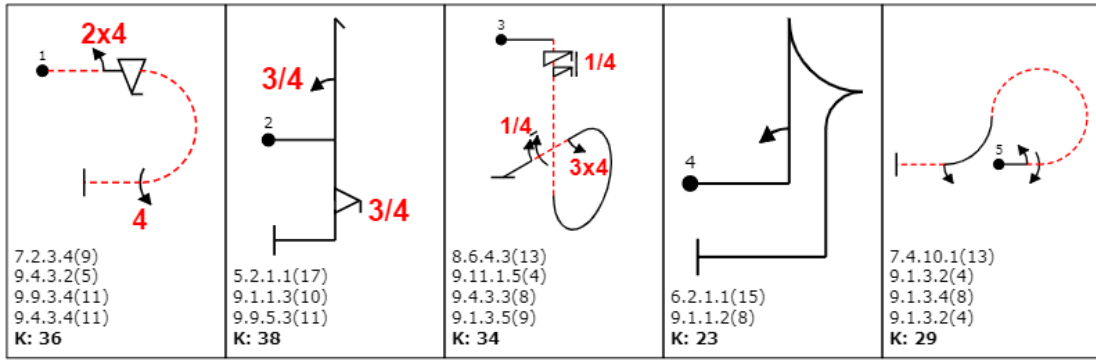

## A2 - 143K

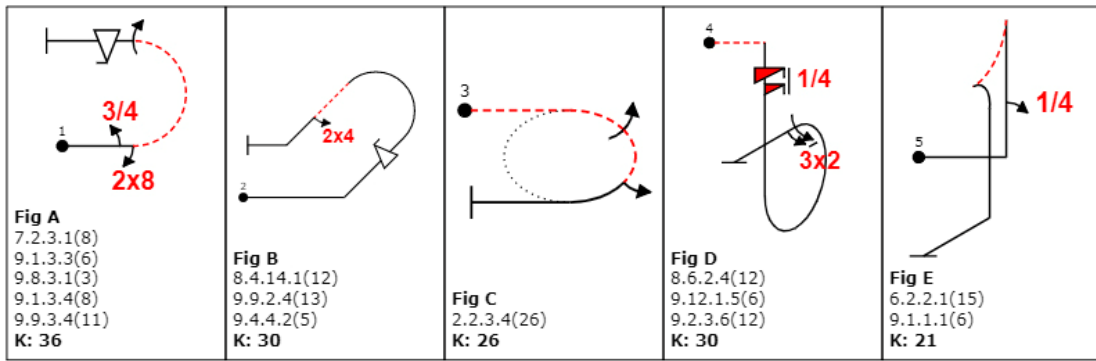

## A3 - 172K

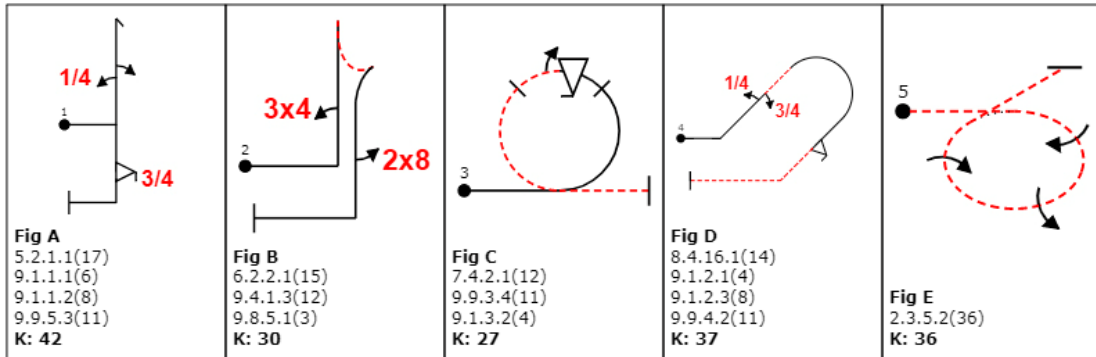

## A4 - 165K

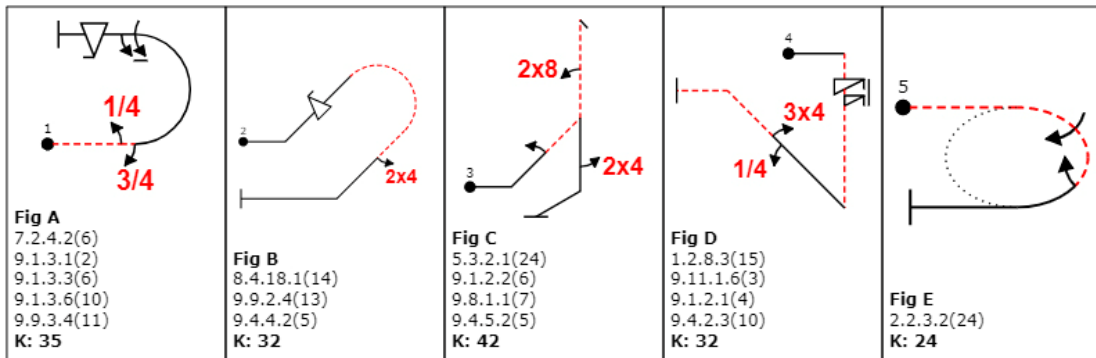

A5 - 138K

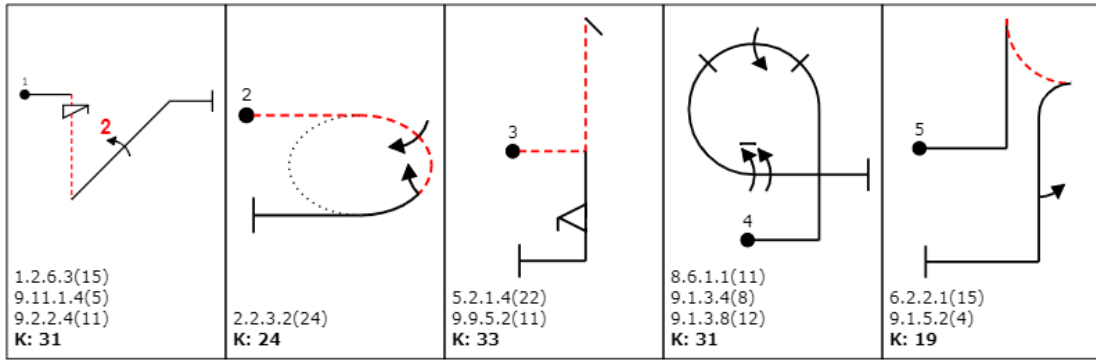

A6 - 138K next page

6 submissions

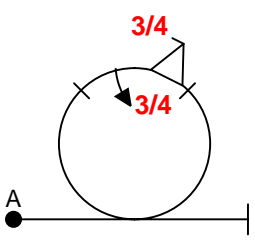
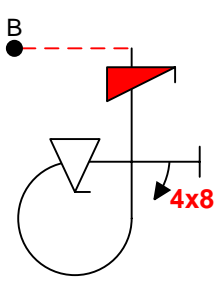
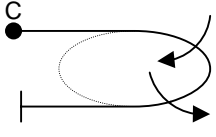
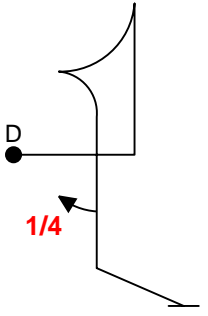
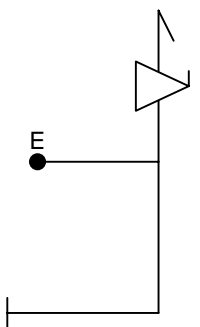
Max Fig K No Limit	1A		6F	
Min Fig K 0		7.4.1.1 10 9.9.3.3 11 9.1.3.3 6		
Total Fig K 138		<b>27</b>		<input type="checkbox"/>
Positioning  30	2B		7G	
Harmony		8.6.2.4 12 9.12.1.4 7 9.9.3.4 11 9.8.3.2 7		
		<b>37</b>		<input type="checkbox"/>
	3C		8H	
		2.2.6.1 25		
		<b>25</b>		<input type="checkbox"/>
	4D		9I	
		6.2.1.1 15 9.1.5.1 2		
		<b>17</b>		<input type="checkbox"/>
	5E		10J	
		5.2.1.1 17 9.9.1.4 15		
		<b>32</b>		<input type="checkbox"/>

Proposals Intermediate 2018

I1 - 110K

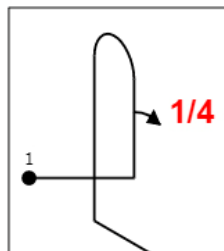
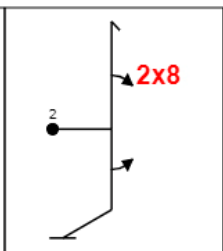
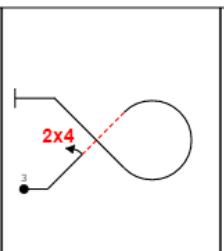
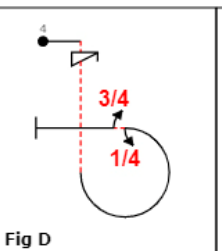
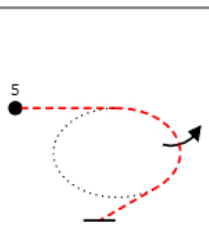
 <p><b>Fig A</b> 8.4.1.1(13) 9.1.1.1(6) K: 19</p>	 <p><b>Fig B</b> 5.2.1.1(17) 9.8.1.1(7) 9.1.5.2(4) K: 28</p>	 <p><b>Fig C</b> 7.3.2.1(14) 9.4.2.2(7) K: 21</p>	 <p><b>Fig D</b> 8.6.4.3(13) 9.11.1.4(5) 9.1.3.1(2) 9.1.3.3(6) K: 26</p>	 <p><b>Fig E</b> 2.1.3.4(16) K: 16</p>
------------------------------------------------------------------------------------------------------------------------------------------------	---------------------------------------------------------------------------------------------------------------------------------------------------------------	------------------------------------------------------------------------------------------------------------------------------------------------	--------------------------------------------------------------------------------------------------------------------------------------------------------------------------------	-----------------------------------------------------------------------------------------------------------------------------------

I2 - 108K, I3 - 95K next 2 pages.

3 submissions

Yak52/Intermediate FreeKnown

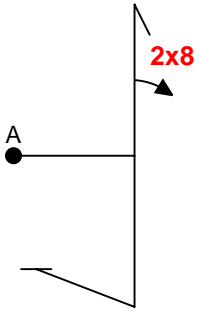
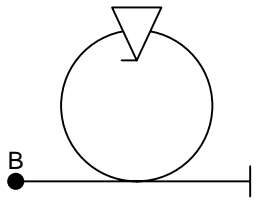
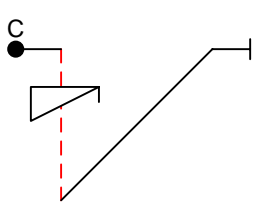
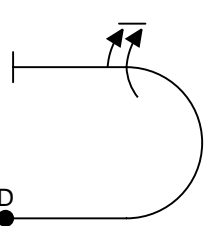
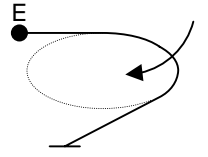
Max Fig K No Limit	<p>1A</p>  <p>5.2.1.1 17 9.8.1.1 7</p> <p style="text-align: right;">24</p>	<p>6F</p> <p style="text-align: right;">□</p>
Min Fig K 0		
Total Fig K 95		
Positioning	<p>2B</p>  <p>7.4.1.1 10 9.9.3.4 11</p> <p style="text-align: right;">21</p>	<p>7G</p> <p style="text-align: right;">□</p>
30		
Harmony		
	<p>3C</p>  <p>1.2.6.3 15 9.11.1.4 5</p> <p style="text-align: right;">20</p>	<p>8H</p> <p style="text-align: right;">□</p>
	<p>4D</p>  <p>7.2.2.1 6 9.1.3.6 10</p> <p style="text-align: right;">16</p>	<p>9I</p> <p style="text-align: right;">□</p>
	<p>5E</p>  <p>2.1.3.1 14</p> <p style="text-align: right;">14</p>	<p>10J</p> <p style="text-align: right;">□</p>

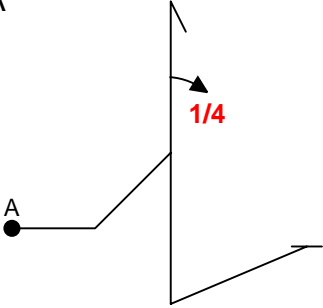
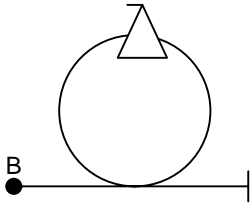
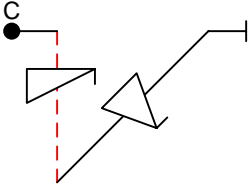
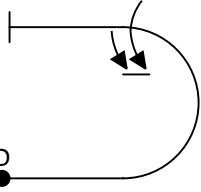
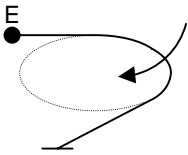

Yak52/Intermediate FreeKnown

Max Fig K No Limit	1A		5.3.1.1 18 9.1.1.1 6	6F	
Min Fig K 0					
Total Fig K 108					<input type="text" value="24"/>
Positioning	2B		7.4.1.1 10 9.9.3.4 11	7G	
30					<input type="text" value="21"/>
Harmony	3C		1.2.6.3 15 9.11.1.4 5 9.9.2.4 13	8H	
					<input type="text" value="33"/>
	4D		7.2.2.1 6 9.1.3.6 10	9I	
					<input type="text" value="16"/>
	5E		2.1.3.1 14	10J	
					<input type="text" value="14"/>