



# FAI Sporting Code

*Fédération  
Aéronautique  
Internationale*

---

## Section 4 – Aeromodelling

# Volume F4 Flying Scale Model Aircraft

2019 Edition

Effective 18th January 2019

Version 2

- F4B - CONTROL LINE SCALE AEROPLANES
- F4C - RADIO CONTROL SCALE AEROPLANES
- F4H - RADIO CONTROL STAND-OFF SCALE AEROPLANES
- ANNEX 6A - JUDGES' GUIDE – STATIC
- ANNEX 6B - JUDGES' GUIDE – CONTROL LINE FLIGHT
- ANNEX 6C - JUDGES' GUIDE – RADIO CONTROL FLIGHT
- ANNEX 6D - JUDGES' GUIDE – FREE FLIGHT
- ANNEX 6E - FORMS
- ANNEX 6F - JUDGES' GUIDE – STAND-OFF SCALE
- ANNEX 6G - JUDGES' GUIDE – RC FLYING SCALE MODEL HELICOPTERS
- F4A - FREE FLIGHT OUTDOOR SCALE AEROPLANES (Provisional)
- F4D - FREE FLIGHT INDOOR RUBBER SCALE AEROPLANES (Provisional)
- F4E - FREE FLIGHT INDOOR CO<sub>2</sub> OR ELECTRIC SCALE AEROPLANES (Provisional)
- F4F - FREE FLIGHT PEANUT SCALE AEROPLANES (Provisional)
- F4G - RADIO CONTROL LARGE SCALE AEROPLANES (Provisional)
- F4J - RADIO CONTROL TEAM SCALE AEROPLANES (Provisional)
- F4K - RADIO CONTROL SCALE HELICOPTERS (Provisional)

*Maison du Sport International  
Avenue de Rhodanie 54  
CH-1007 Lausanne  
Switzerland  
Tel: +41(0)21/345.10.70  
Fax: +41(0)21/345.10.77  
Email: [info@fai.org](mailto:info@fai.org)  
Web: [www.fai.org](http://www.fai.org)*

**FEDERATION AERONAUTIQUE INTERNATIONALE**  
**MSI - Avenue de Rhodanie 54 – CH-1007 Lausanne – Switzerland**

---

Copyright 2019

All rights reserved. Copyright in this document is owned by the Fédération Aéronautique Internationale (FAI). Any person acting on behalf of the FAI or one of its Members is hereby authorised to copy, print, and distribute this document, subject to the following conditions:

- 1. The document may be used for information only and may not be exploited for commercial purposes.**
- 2. Any copy of this document or portion thereof must include this copyright notice.**
- 3. Regulations applicable to air law, air traffic and control in the respective countries are reserved in any event. They must be observed and, where applicable, take precedence over any sport regulations.**

Note that any product, process or technology described in the document may be the subject of other Intellectual Property rights reserved by the Fédération Aéronautique Internationale or other entities and is not licensed hereunder.

# RIGHTS TO FAI INTERNATIONAL SPORTING EVENTS

All international sporting events organised wholly or partly under the rules of the Fédération Aéronautique Internationale (FAI) Sporting Code<sup>1</sup> are termed *FAI International Sporting Events*<sup>2</sup>. Under the FAI Statutes<sup>3</sup>, FAI owns and controls all rights relating to FAI International Sporting Events. FAI Members<sup>4</sup> shall, within their national territories<sup>5</sup>, enforce FAI ownership of FAI International Sporting Events and require them to be registered in the FAI Sporting Calendar<sup>6</sup>.

An event organiser who wishes to exploit rights to any commercial activity at such events shall seek prior agreement with FAI. The rights owned by FAI which may, by agreement, be transferred to event organisers include, but are not limited to advertising at or for FAI events, use of the event name or logo for merchandising purposes and use of any sound, image, program and/or data, whether recorded electronically or otherwise or transmitted in real time. This includes specifically all rights to the use of any material, electronic or other, including software, that forms part of any method or system for judging, scoring, performance evaluation or information utilised in any FAI International Sporting Event<sup>7</sup>.

Each FAI Air Sport Commission<sup>8</sup> may negotiate agreements, with FAI Members or other entities authorised by the appropriate FAI Member, for the transfer of all or parts of the rights to any FAI International Sporting Event (except World Air Games events<sup>9</sup>) in the discipline<sup>10</sup>, for which it is responsible<sup>11</sup> or waive the rights. Any such agreement or waiver, after approval by the appropriate Air Sport Commission President, shall be signed by FAI Officers<sup>12</sup>.

Any person or legal entity that accepts responsibility for organising an FAI Sporting Event, whether or not by written agreement, in doing so also accepts the proprietary rights of FAI as stated above. Where no transfer of rights has been agreed in writing, FAI shall retain all rights to the event. Regardless of any agreement or transfer of rights, FAI shall have, free of charge for its own archival and/or promotional use, full access to any sound and/or visual images of any FAI Sporting Event. The FAI also reserves the right to arrange at its own expense for any and all parts of any event to be recorded.

---

1	FAI Statutes,	.....	Chapter 1, .....para. 1.6
2	FAI Sporting Code, Gen. Section,	.....	Chapter 4, .....para 4.1.2
3	FAI Statutes,	.....	Chapter 1, .....para 1.8.1
4	FAI Statutes,	.....	Chapter 2, .....para 2.1.1; 2.4.2; 2.5.2 and 2.7.2
5	FAI By-Laws,	.....	Chapter 1, .....para 1.2.1
6	FAI Statutes,	.....	Chapter 2, .....para 2.4.2.2.5
7	FAI By-Laws,	.....	Chapter 1, .....paras 1.2.2 to 1.2.5
8	FAI Statutes,	.....	Chapter 5, .....paras 5.1.1, 5.2, 5.2.3 and 5.2.3.3
9	FAI Sporting Code, Gen. Section,	.....	Chapter 4, .....para 4.1.5
10	FAI Sporting Code, Gen. Section,	.....	Chapter 2, .....para 2.2.
11	FAI Statutes,	.....	Chapter 5, .....para 5.2.3.3.7
12	FAI Statutes,	.....	Chapter 6, .....para 6.1.2.1.3

**PAGE DELIBERATELY LEFT BLANK**

## **SECTION 4C – MODEL AIRCRAFT –**

### **F4B – CONTROL LINE SCALE; F4C – RADIO CONTROL SCALE; F4H – RADIO CONTROL STAND-OFF SCALE**

#### **Part Six – Technical Regulations for Scale Contests**

- 6.1 General Rules and Standards for Static Judging
- 6.2 Class F4B - Control Line Scale Aeroplanes
- 6.3 Class F4C - Radio Controlled Scale Aeroplanes
- 6.9. Class F4H - Radio Controlled Stand-Off Scale Aeroplanes

Annex 6A – Judges' Guide – Static

Annex 6B – Judges' Guide – Control Line – Flight

Annex 6C – Judges' Guide – Radio Control – Flight

Annex 6E – Forms

Annex 6F – F4H Static Judges' Guide

#### **Provisional Classes**

- 6.4 Class F4A - Free Flight Outdoor Scale Aeroplanes
  - 6.5. Class F4E - Free Flight Indoor CO<sub>2</sub> or Electric Scale Aeroplanes
  - 6.6. Class F4D - Free Flight Indoor Rubber Scale Aeroplanes
  - 6.7. Class F4F - Free Flight Peanut Scale Aeroplanes
  - 6.8. Class F4G - Radio Controlled Large Scale Aeroplanes
  - 6.10 Class F4J - Radio Controlled Team Scale Aeroplanes
  - 6.11 Class F4K - Radio Controlled Scale Helicopters
- Annex 6D – Judges' Guide – Free Flight Outdoor Scale Aeroplanes – Flight
- Annex 6G – Judges' Guide – Radio Controlled Scale Helicopters – Flight

**THIS 2019 EDITION INCLUDES THE FOLLOWING AMENDMENTS MADE TO 2018 CODE**

**These amendments are marked by a double line in the right margin of this edition**

Paragraph	Plenary meeting approving change	Brief description of change	Change incorporated by
6.1.6.	2018	Amendment regarding spinners in support of Rule 6.1.6. d)	Pål Anthonisen Subcommittee Chairman & Kevin Dodd Technical Secretary
6.1.9.2.		Rewrite paragraph to clarify and correct the existing.	
6.1.9.2 & Forms		Consequential removal of reference to non-aerobatic aircraft following 6.3.6.11, (not minuted).	
6.1.9.3.		Scale is required to be entered on the Flight Score sheet.	
6.1.9.4.		Clarification to documentation for cruising speed.	
<b>F4C</b>			
6.3.6.11.		Change category a) in Realism in Flight, from 'Model Sound' to 'Flight Presentation'. Consequential changes to F4G, F4H and F4K and associated documentation.	
6.3.7.		Consequential change resulting from renumbering the list with the inclusion of the Cuban Eight variations.	
6.3.7.		Consequential change resulting from amendment 6.3.6.11.	
6.3.7.		Addition to the list of manoeuvres of the variations of the Cuban Eight theme. Remainder of the list renumbered.	
Annex 6C.3.6.11.		Consequential amendment to Judges Guide to explain 'Flight Presentation' category.	
Annex 6C.3.7.		Consequential additions and renumbering in the Judges Guide - clarification of the Cuban Eight variations.	
<b>F4K</b>			
Annex 6G.1		Clarification: the parts of the model helicopter that are excluded from static judging.	

**Four-Year Rolling Amendments for Reference**

Paragraph	Plenary meeting approving change	Brief description of change	Change incorporated by
<b>F4C</b>	2017		Johan Ehlers Subcommittee Chairman & Kevin Dodd Technical Secretary
6.3.1.		<b>Early implementation – effective 1<sup>st</sup> June 2017</b> Clarification regarding permitted and not permitted technologies.	
<b>F4K</b>			
Annex 6G: 2B,4A, 4B, 4C, 4D, 4H, 4I, 4J		<b>Early implementation – effective 1<sup>st</sup> June 2017</b> Changes made to clarify confusing details between description, diagram and list of errors in Annex 6G.	
Annex 6E	n/a	Forms for use in competitions available for download.	

Paragraph	Plenary meeting approving change	Brief description of change	Change incorporated by
<b>F4, F4C, F4H</b>	2016	<b>Approved for early implementation at 01/05/2016</b>	Johan Ehlers Subcommittee Chairman & Kevin Dodd Technical Secretary
6.1.11.		Normalisation of static scores	
6.1.13.		Procedure for Declaration Forms – handling protests	
6.3.9.		F4C – normalisation of total flight score	
6.3.10.		F4C – calculating final normalised scores	
6.9.5.		F4H – normalisation of static scores	
6.9.7.		F4H – normalisation of total flight score	
6.9.8		F4H – calculating final normalised scores	
<b>F4</b>		<b>Approved for normal implementation at 01/01/2017</b>	
6.1.3.		Amend the circumstances and composition where there are two panels of static judges	
6.1.4.		Amend the circumstances and composition of judging panels for F4C and F4H WCh and CCh.	
6.1.6.j)		Interruption of contest due to wind speed	
6.1.14.		Amend procedure for demonstration of functional scale detail during static judging	

<b>F4B</b>	2016		Johan Ehlers Subcommittee Chairman & Kevin Dodd Technical Secretary
6.2.10.		National team classification	
<b>F4C</b>			
6.3.9.		Consequential change of 6.1.4. for tallying flight scores	
6.3.10.		National team classification	
<b>F4H</b>			
6.9.4.		Consequential change of 6.1.4.	
6.9.5.		Amend static judging K-Factors	
6.9.6.1.		Clarify photographic evidence requirements	
6.9.8.		National team classification	
6.9.9.1.		Clarify photographic evidence requirements for F4H	
<b>Annexes</b>			
6A		Amend the heading to direct F4H to Annex 6F	
6A.1.9.		Clarify requirements for presentation of documentation	
6A.1.10.1.		Clarify the use of photographs and drawings	
6A.1.10.4		Paragraphs rearranged to agree with heading	
6C.3.7.W.		Clarify the 'wingover' manoeuvre	
6F.2 (F4H)		Consequential change for 6A.1.10.1	
6F.3.		Consequential change regarding originality	
6G.2.2A		Clarify manoeuvre A (diagram) for class F4K	
6G.2.4E	Clarify manoeuvre E (conflicting details) for class F4K		
6G.2.4F	Clarify manoeuvre F (conflicting details) for class F4K		
6.11.8	n/a	Correct the K-Factors for the optional manoeuvres for class F4K from 7 to 10 to agree with 6.11.7.	

Paragraph	Plenary meeting approving change	Brief description of change	Change incorporated by
<b>There were no changes at the 2015 Plenary Meeting</b>			

Paragraph	Plenary meeting approving change	Brief description of change	Change incorporated by
6.1.1	2014	Amended definition to include F4K class.	Kevin Dodd Technical Secretary
6.1.5		Clarified and added detail to scoring.	
<b>Annex 6A &amp; 6.9.4 c)</b>		Consequential change of added increments (tenths) to static scoring.	
6.1.9.4 a)		Added to requirements of photographic evidence.	
6.1.9.4 e)		Amended rationale for the competitor's declaration.	
6.1.13		Added new paragraph to clarify the 'builder of the model' rule with regards to commercially available components.	
<b>F4C</b>			
6.3.6		Changed 'engine sound' to 'model sound' with consequential change to 6C.3.6.11 Judges Guide	
6.3.7		Added manoeuvre AA to Optional Demonstrations with consequential changes to Annex 6C, the Judges Guide and Annex 6E.2, the Score Sheet.	
<b>Annex 6C 6C.3.6.11</b>		F4C Judges Guide – Flying Schedule Consequential change plus amended and extended description of the meaning of 'realism in flight'.	
<b>6C.3.7T</b>		Added description and manoeuvre diagram AA for 'straight flight at low speed'.	
<b>F4K</b>		Added new class F4K and a new Judges' Guide	
<b>Annex 6G</b>		Judges' Guide – F4K - Flight	
<b>Annex 6E.2</b>		Added F4K Consequential change to Score Sheet – 'model sound'	

Note: The word "engine" means combustion engines and "motor" means electric, CO<sub>2</sub> and extensible motors.

### **RULE FREEZE FOR THIS VOLUME**

With reference to paragraph A.10.3. of the Volume *CIAM General Rules*:

In all classes, the two-year rule for no changes to model aircraft/space model specifications, manoeuvre schedules and competition rules will be strictly enforced. For Championship classes, changes may be proposed in the year of the World Championship of each category.

For official classes without Championship status, the two-year cycle begins in the year that the Plenary Meeting approved the official status of the class. For official classes, changes may be proposed in the second year of the two-year cycle.

This means that in Volume F4:

- (a) changes can next be made at the 2020 Plenary meeting for application from January 2021;
- (b) provisional classes are not subject to this restriction.



The only exceptions allowed to the two-year rule freeze are genuine and urgent safety matters, indispensable rule clarifications, noise rulings and changes to the provisional classes.



## VOLUME F4

### PART SIX - TECHNICAL RULES FOR FLYING SCALE AIRCRAFT CONTESTS

#### 6.1 GENERAL RULES AND STANDARDS FOR STATIC JUDGING OF SCALE MODEL AIRCRAFT

##### 6.1.1. Definition of Scale Model Aircraft:

A scale model aircraft shall be a reproduction of a heavier than air, man-carrying aircraft. The classes F/A/B/C/D/E/F/G/H/J/ are fixed-wing classes; the class F4K is a motorised rotary wing class. The aim of scale contests is to recreate the accurate appearance and realism of the full-size aircraft as best appropriate to each model aircraft class. This shall apply equally to static judging and flight performance.

Note: To indicate the subject full-size aircraft being scale modelled, the word "prototype" may be used.

##### 6.1.2. System of Rules

Rules are numbered as follows:

- 6.1. General rules and standards for judging Fidelity to Scale
- 6.2. Control Line Flying Scale Model aircraft
- 6.3. Radio Controlled Flying Scale Model aircraft

##### 6.1.3. Competition Programme:

A competition programme for a particular event shall consist of part 6.1 plus the regulations for the specific event. Rules for the C/L events shall consist of 6.1. plus 6.2. and for the R/C events, shall be 6.1. plus 6.3.

The C/L event will commence with static judging, flying will start upon completion of this.

The R/C event will commence with flying on the first day of competition, with static judging commencing after the first model aircraft has been flown. Thereafter flying and static judging will be carried out concurrently, model aircraft being flown before being presented for static judging. No competitor will be required to fly more than one flight before being static judged.

If there are more than 45 competitors by the official closing date for entries in a World or Continental Championship, the organiser may use two separate panels for static judging. Each panel shall consist of two judges. The first panel will judge Scale Accuracy (6.1.10.1 – Side View, End View and Plan View). On completion of this, the second panel will judge the remaining aspects (6.1.10.2. – 6.). Under these circumstances the R/C event will commence with static judging. Flight judging will commence once the first 10 models have been statically assessed. In this case all competitors shall have their static judging done before the first flight.

##### 6.1.4. Judges

The organiser of Scale R/C World or Continental Championship (F4C) shall appoint three (or four for two panels) judges to do static judging, plus a separate panel of three judges to judge the flying. If there are more than 45 competitors at a World Championship, then the organisers may use two static panels of two judges each as well as two flight lines with three judges on each flight line.

For Championships with less than 45 competitors in a class, the organiser is allowed to use two sets of two static judges instead of one set of three judges to speed up static judging.

Within each class (F4C and F4H) all the judges (static and flying) must be of a different nationality and selected from a list submitted by the NACs for guidance and approved by the CIAM Bureau.

In the case of World and Continental Championships, the flight and static judges' panels shall contain at least one member of the Scale CIAM Sub-committee. The CIAM Bureau must approve the two panels of judges prior to the World or Continental Championships.

Within each panel of Judges (Static and Flying), there must be a common language. The organiser is allowed to use two judges of the same nationality, one in each class, F4C and F4H.

For World Championships the Panel of Judges should be composed of judges from at least three continents.

##### 6.1.5. Scoring

Where a K-factor (K) is noted, marks shall be awarded from 0 to 10 inclusive using increments of half a mark for Flight Judging and a tenth of a mark for Static Judging. The score shall then be calculated by multiplying the marks awarded by the K-factor (K).

### 6.1.6. Remarks

- a) All model aircraft shall become airborne in the manner of their prototype.
- b) In the absence of suitable water surface conditions, model aircraft of seaplanes are permitted to use wheels or wheeled dollies for take-off. The release or dropping of a dolly immediately after take-off will not therefore be penalised. Deviation from Scale because of the inclusion of permanently attached wheels, skids or similar non-prototype devices in the model aircraft structures will not be taken into consideration in the scoring of Fidelity to Scale and Craftsmanship.
- c) No parts of a model aircraft, except propeller and spinner may be removed, nor may anything except a dummy pilot and antenna be added externally to the model aircraft, between scale judging and flying. Bombs, drop-tanks, etc must be presented for static judging, but may be replaced before flying by simpler and repairable examples of the same shape, colour, size and weight. Any infringement will result in disqualification. Additional non-prototype air inlets are permitted provided they are covered by movable hatches for static judging; these hatches may be moved or opened manually prior to flight, or if in flight by means of radio control. Necessary repairs due to flight damage are permitted, but the maximum weight limit still applies. The appearance of the model aircraft in flight must not be unduly affected.
- d) A flying propeller of any form or diameter may be substituted for a scale propeller. The size, shape and colour of the spinner may not be changed and the spinner used for flight must be presented with the model for static judging.  
 Note: Substitution for a scale propeller relates only to powered propellers that were intended to propel the subject aircraft. If a model aircraft of a multi-engined aircraft uses non-powered (windmilling) propellers, these may not be changed between static and flying. Features such as for example, the small generator propeller on the nose of an aircraft such as a Me163, may likewise not be changed for flying propellers
- e) Metal bladed flying propellers are forbidden.
- f) Explosives must not be dropped.
- g) If the pilot of the prototype is visible from the front or from the side during flight, a dummy pilot of scale size and shape must be equally visible during flight in the model aircraft. If such a pilot is not fitted, the total flight score shall be reduced by 10%. The dummy pilot may be present during static judging but will not be taken into account.
- h) A measurement of weight must be undertaken immediately after the first flight of each Model aircraft. No modification of the model aircraft except exhausting of fuel and cleaning of the model aircraft is allowed. If found to be overweight, then zero points will be awarded for that flight and the model aircraft must be re-weighed after each subsequent flight. The officials responsible for weighing the model aircraft and the device to be used shall be available to all competitors for weighing prior to the first flight of the contest. The tolerance of the weighting equipment to be added to the maximum weight (i.e. C/L model aircraft max weight 6 kg, weight tolerance 15 grams gives total allowed weight of 6.015 Kg as maximum).
- i) Any model aircraft that, in the opinion of the Chief Judge or the Flight Line Director, appears to be noisy in flight will have to submit to a noise check after that flight. Turbine powered model aircraft are exempt from such noise checks. For details see sections 6.2.1 (F4B) and 6.3.2 (F4C). The organiser must provide all competitors with the possibility to conduct noise checks prior to the competition if competitors so request.
- j) The contest should be interrupted or the start delayed by the contest director in the event that the wind is continuously stronger than 9 m/s measured at two (2) metres above the ground at the flight line, for at least one minute.

### 6.1.7. Number of Model Aircraft

Each competitor may compete only with one model aircraft in any one category, Control Line or Radio Control.

### 6.1.8. Helpers

Each competitor is permitted one (1) helper during a flight. An additional helper may assist with engine starting and pre-flight preparation, should the competitor require this. All but one helper must retire clear of the flying area before the take-off is announced. For radio control events no helper may touch the transmitter during an official flight.

The timekeeper is responsible for watching that helpers do not touch the transmitter once the first manoeuvre has been called. If a helper touches the transmitter the flight is scored zero.

cont/...

### **6.1.9. Documentation (Proof of Scale)**

- 6.1.9.1. Proof of scale is the responsibility of the competitor.
- 6.1.9.2. The exact name and designation of the prototype must be entered on the score sheets, the proof of scale documentation and the Competitors Declaration.
- 6.1.9.3. The model aircraft may be built to any scale, but the scale must be entered on the Flight Score sheets.
- 6.1.9.4. To be eligible for Fidelity to Scale (Static) points the following is the minimum documentation that must be submitted to the judges  
(See Annex A - 6A.1.9. for recommended presentation of documentation):
  - a) Photographic evidence:

At least three photographs or printed reproductions of the prototype, including at least one of the actual subject aircraft being modelled are required. Each of these photographs or printed reproductions must show the complete aircraft, preferably from different aspects and must not be smaller than A5. These main photos must be submitted in triplicate, the second and third copies may be photocopies. Photographs of the model are not permitted unless the model is posed alongside the full size prototype and the photo used as proof of colour. The use of photographs based on digital files which show evidence of being enhanced or manipulated shall result in disqualification. The photographic evidence is the prime means of judging scale accuracy against the prototype.
  - b) Scale Drawings:

Accurate scale drawing of the full-size aircraft that show at least the 3 main aspects of Side View, Upper Plan View and Front End View. These drawings must be to a common scale giving a minimum span of 250 mm, and a maximum span of 500 mm or if the fuselage is longer than the wingspan, these measurements will be made on the fuselage. The drawings must be submitted in triplicate. Unpublished drawings by the competitor or other draftsman are not acceptable unless certified accurate in advance of the contest by an authoritative source such as the respective National Scale Committee or equivalent, the builder of the original aircraft, or other competent authority.
  - c) Proof of Colour:

Correct colour may be established from colour photographs, from published descriptions if accompanied by colour chips certified by a competent authority, from samples of original paint, or from published colour drawings, eg "Profile" type publications.
  - d) Aircraft speed:

The cruising speed of the subject aircraft must be stated on the Competitors Declaration Form (Annex 6.E1) and also entered on all flight score sheets before the sheets are passed to the Flight Judges. In the case of early aircraft, where only maximum speeds are likely to be listed, the maximum speed alone may be quoted. The competitor must be prepared to substantiate this information if required.
  - e) Competitor's declaration:

The competitor must include in his documentation a signed declaration that his model conforms to the requirements and rules appropriate to the class of model. The Competitor's Declaration also contains a questionnaire which is used by the Judges to determine the origin of the model design and its construction and the extent of use of commercially available components.  
The declaration form is at ANNEX 6E.1

*cont/...*

**6.1.10. Judging for Fidelity to Scale and Craftsmanship**

K - Factor

- 1. Scale Accuracy
  - a. Side view 13
  - b. End view 13
  - c. Plan view 13
- 2. Colour
  - a. Accuracy 3
  - b. Complexity 2
- 3. Markings
  - a. Accuracy 8
  - b. Complexity 3
- 4. Surface texture and scale realism
  - a. Surface Texture 7
  - b. Scale Realism 7
- 5. Craftsmanship
  - a. Quality 12
  - b. Complexity 5
- 6. Scale detail
  - a. Accuracy 9
  - b. Complexity 5

Total K Factor .....K = 100

Items .1 to be judged at a minimum distance of 3m in F4B, and 5m in F4C, from the centre of the model aircraft. Judges must not touch the model aircraft.

**6.1.11. Static Scoring**

For Flying Scale Contests the combined Fidelity to Scale and Craftsmanship points shall be the aggregate sum of points awarded by the three static judges. These static points shall be used for final scores classification only when the model aircraft has completed an official flight.

Normalisation:

The total of the competitors' static scores will be normalised to 1000 points as follows:

$$\text{Static Points}_x = S_x/S_w \times 1000$$

Where:

Static Points<sub>x</sub> = Normalised Static Score for competitor x

S<sub>x</sub> = Static Score for competitor x

S<sub>w</sub> = Highest Static Score

**6.1.12 Organisation of Scale Events**

For transmitter and frequency control see Volume *General Rules* Section C, paragraph C.16.2

The flying and static order of the various countries and competitors will be established by means of a draw before the start of the contest. Team Managers shall nominate their individual team members' order as first, second or third.

The flight order of the competitors will not be changed unless, in the case of R/C events, the organisers need to do so to avoid frequency clashes. Sufficient flexibility in frequency sequencing must be provided to allow a competitor to make use of his transmitter, at the latest, by the time he enters the N° 1 ready box. There shall be no substitution of one team member's slot for another team member's slot.

The second flight round will start one-third the way down the flying order. The final round will be flown in ascending order with regard to the preliminary placing after two flight rounds and static.

Competitors must be called at least seven minutes for F4B and five minutes for F4C before they are required to occupy the starting area (see 6.2.4 flying time F4B).

cont/...

### **6.1.13 Builder of the Model**

Scale models must be constructed and finished solely by the competitor. The only exceptions to this rule are for models entered in Class F4H and for team entries entered in Class F4J.

Note: The use of the word “constructed” in this context means that the competitor is the person who has done all the work on the model.

The Competitor must also prepare the model for flight, although helpers are permitted (see paragraph 6.1.8).

Commercially available components, machined parts, die or laser cut parts and prefabricated or moulded airframe components which are manufactured by a third party, whether specifically for the model or supplied as part of a kit, may be used in the construction of scale models.

Details of these items (excluding fixings, i.e. screws, nuts a bolts etc) must however, be entered on the Competitors Declaration Form and if they affect the visible scale accuracy or craftsmanship of the model they will result in a reduction of the marks awarded during static judging.

If any commercially available parts have been modified by the competitor to improve scale accuracy then the evidence of this work must be supplied (attached to the declaration) in order for the Judges to assess the craftsmanship.

If found in violation of this rule the competitor may be disqualified from the contest.

Copies of the Declaration Forms of all contestants shall be made available for examination by all contestants. If a contestant or number of contestants disagree with what has been claimed by a contestant, he/they may lodge an official protest by the normal procedure together with clear proof of their claim within twenty four hours of the publication of the forms. The protest is then handled by the jury as per normal procedure and they decide on the validity of the protest and a suitable sanction.

### **6.1.14 Demonstration of Functional Scale Detail during Static Judging**

The model should be presented for static judging supported only by its undercarriage or normal aids to take-off and landing. If applicable, folding wings may then be unfolded and locked for flight in the manner of the full size aircraft. With the exception of undercarriage retraction, a demonstration of functional detail of any part of the model is permitted providing such functionality is normally only operable by the pilot or aircrew of the full size aircraft, from their crew position.

## 6.2. CLASS F4B - CONTROL LINE SCALE MODEL AEROPLANES

### 6.2.1. General Characteristics

Maximum weight: The weight of the complete model aircraft in flying condition without fuel, but including any dummy pilot, shall not exceed 7 kg.

Motive Power: a) Rockets or pulse jets may not be used.  
b) The maximum thrust for a turbine engine shall be 6 kg. (Or 60 Newton)

Note: For all other scale model aircraft specifications see volume *General Rules*, Section B.

If a model aircraft appears to be noisy in flight, the Judges or Contest Director/Circle Marshall can demand a noise test. The model aircraft will then be impounded by the flightline official immediately following the flight. No modification or adjustment to the model aircraft shall be permitted other than refuelling. If the model aircraft features variable pitch propeller(s), the noise test will cover the total variation of pitch. The model aircraft shall be tested by a noise steward and in the event the model aircraft failing the noise test will be re-tested by a second noise steward, using a second noise meter. If the model aircraft fails the retest, the score for the preceding flight shall be zero. The sonometers must be of good quality with a test system (reference noise).

The maximum noise level will be 96 dB(A) measured at 3 metres from the centre line of the model aircraft with the model aircraft placed on the ground, over concrete or macadam, at the flying site. With the engine running at full power, measurement will be taken 90 degrees to the flight path on the side chosen by the competitor and downwind from the model aircraft. The microphone will be placed on a stand 30 cm above the ground in line with the engine(s). No noise reflecting objects shall be nearer than 3 metres to the model aircraft or the microphone. If a concrete or macadam surface is not available then the measurement may be taken over bare earth or very short grass, in which case the maximum noise level will be 94 dB(A). In the case of multi-engine model aircraft, the noise measurement will be taken at 3 metres from the closest engine to the noise meter and the maximum noise level will be the same as for single engine model aircraft. Turbine engines will not be subject to noise measurement.

### 6.2.2. Control Mechanism

a) All Control Line Flying Scale Model Aircraft must be permanently attached to two or more non-extensible wires or cables during flight.

b) Primary Control Function:

The model aircraft's flight path may only be controlled by manually activated and mechanically linked flight control elements. This must be by a hand-held control handle manipulated by the pilot located on the ground at the centre of the model aircraft's flight circle. No automatic control of the Primary Control Function shall be permitted.

c) Secondary Control Functions:

These may include (but are not limited to) control of engine/s, landing gear, landing flaps. Secondary Control Functions may be controlled by the pilot via wires/cables, or may function completely automatically. The frequency of any electro-magnetic pulses sent through wires/cables shall not exceed 30 kHz

d) No control of either Primary or Secondary Control Functions other than through wires/cables shall be permitted.

e) Before each flight the entire mechanism including control line and their attachments to the model aircraft and the control handle, shall be subject to a pull test equal to 5 times the weight of the model aircraft, as recorded at Processing, with a maximum of 25 kg. Control line length (central point of handgrip to vertical centre line of model aircraft) shall be not less than 15 metres or more than 21.5 metres.

f) The safety strap connecting the competitor's wrist to the control handle must be attached for the whole flight. The circle marshal shall ensure that this requirement is met and any attempt to take off in breach of this will result in disqualification of that flight.

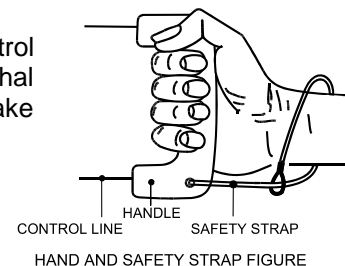

**6.2.3. Official Flights**

- a) Each competitor will be called to fly three times. To be eligible for flight points for that flight he must execute an official flight within the required time limit (see 6.2.4.) on each occasion.
- b) If a competitor is unable to start or complete a flight and, in the opinion of the Contest/Flightline Director the cause is outside the control of the competitor, the Contest/Flightline Director may, at his discretion, award the competitor a reflight. The Contest/Flightline Director shall decide when the reflight shall take place.
- c) An official flight commences at the earliest of the following:-
  - i) The competitor signals to the timekeeper that he is commencing to start his engine(s).
  - ii) Two minutes after the competitor is instructed to start his flight (see 6.2.4.).
  - iii) An official flight is terminated when the model aircraft lands and stops, except during the option 6.2.7.J (Touch and Go and the taxi demonstration after landing).

**6.2.4. Flying Time**

Competitors must be called at least 7 minutes before they are required to occupy the starting area. Each competitor shall have 9 minutes to complete each flight programme. Time shall start when the competitor begins to crank the engine, or two minutes after entry to the starting area, whichever is the first. The model aircraft must become airborne within the first five minutes (plus one minute for each additional engine, in excess of one). No points may be scored after the expiry of the time limit (9 minutes plus one for each added engine).

**6.2.5. Starting Time**

- a) If the model aircraft is not airborne within the 5 minutes, plus one minute for each additional engine, the competitor must immediately make room for the next competitor. If the engine(s) stop after take-off has begun but before the model aircraft is airborne, it may be restarted within the 5 minutes starting period.
- b) There is only one attempt allowed to repeat the take-off.  
In the case of a repeated attempt, no points will be assigned for the take-off.

Note: In this case, rule 6.2.5.a. still applies.

**6.2.6. Flight**

The manoeuvres must be executed in the order listed below. Between the end of one manoeuvre and the start of the next one, the competitor must fly the model aircraft a minimum of two laps. Less than two laps between the end of one manoeuvre and the start of the next one will result in zero points for the subsequent manoeuvre.

6.2.6.1. Taxi & take-off.....	K = 14
6.2.6.2. 5 laps of straight level flight .....	K = 8
6.2.6.3. Optional demonstration.....	K = 12
6.2.6.4. Optional demonstration.....	K = 12
6.2.6.5. Optional demonstration.....	K = 12
6.2.6.6. Optional demonstration.....	K = 12
6.2.6.7. Landing & taxi .....	K = 14
6.2.6.8. Realism in flight	
a) Engine noise (realistic tone and tuning)...	K = 4
b) Speed of the model aircraft.....	K = 6
c) Smoothness of flight.....	K = 6
Total K-factor .....	K = 100

Note: The scale of the model aircraft and the cruising speed or maximum speed of the prototype must be stated on the flight scoring form.

**6.2.7. Optional Demonstrations**

The competitor must be prepared to give evidence to the judges during the static judging that the flying options selected for the flights are typical and within the normal capabilities of the aircraft subject modelled. The F4B chief judge will make the decision before the flight commences.

The selected options must be given to the judges in writing before take-off. The options may be flown in any order but the order must be marked on the score sheet and any manoeuvre flown out of order will be marked ZERO.

*cont/...*

Any demonstration of cargo doors or bomb doors must be done in conjunction with a cargo drop or bomb drop. If no cargo or ordnance is dropped, the manoeuvre will score ZERO.

Not more than one (1) drop option may be nominated.

Any model aircraft that flies with wheels down whereas the prototype actually features retractable landing gear shall have the total flight score reduced by 25%.

Only one attempt is permitted for each manoeuvre, the only exception is the procedure of getting a model aircraft airborne, as defined in 6.2.5.b.

All options carry a K factor of 12.

The FOUR optional demonstrations must be selected from the following list:

A Multi-engine option – in order to qualify for full multi-engine points, all engines must run for the complete flight. Should any engine cut prematurely, then the marks will be reduced accordingly.

Note: The K factor of 12 applies to any multi-engine subject. No points are awarded for each individual engine.

B Retract and extend landing gear.

C Retract and extend flaps.

D Drop bombs or fuel tanks.

E High flight over 30° line angle.

F One inside loop.

G Three inverted laps.

H Wingover.

I Figure eight.

J Touch and go.

K Lazy Eight

L Parachute drop.

M 1<sup>st</sup> Flight function by subject aircraft.

Competitors may demonstrate one different flight function of their own choice, but must be prepared to supply evidence that the function was performed by the prototype modelled. Competitors must indicate to the Flight Judges the nature of the demonstration before going to the flight line.

N Overshoot.

#### **6.2.8. Marking (flight points):**

Each manoeuvre may be awarded marks between 0 and 10, using increments of half a mark, by each judge during the flight. The marks are multiplied by a coefficient that varies with the difficulty of the manoeuvres.

#### **6.2.9. Flight Score:**

The flight score shall be the sum of the points awarded by all three judges in 6.2.6.

#### **6.2.10. Final Scoring:**

Add points earned in 6.1.10. to the average score of the two best flights under 6.2.9. If the competitor has achieved only one flight, the points awarded for that flight will be divided by two.

If for any cause beyond the control of the organisers (eg B.11.1.) less than three official rounds can be flown, the scoring shall be completed as follows:

- a) If two rounds are flown, the average of the two flights as in 6.2.9 is used.
- b) If only one round is flown, the single flight score of that one round is recorded.
- c) The scores in an official round can be recorded only if all competitors had equal opportunity for a flight in that round.

The national team classification for World or Continental Championships is established after the completion of the championship by adding the scores of the three members of the team together unless there is a fourth member of the team (who must always be a junior) in which case it will be the three best scoring members.

In the case of a national team tie, the team with the lower sum of place numbers, given in order from the top, wins. If still equal, the best individual placing decides.



### 6.2.11. Flying Area

Contest organisers should clearly mark the following circles on the ground.

- 1) The pilot's circle - radius 1.5 metres

This is the area in which a competitor should remain. A warning will be given by the Circle Marshal if the competitor steps outside this 1.5 metre radius "Pilot's Circle", but no penalty will be incurred.

- 2) The penalty circle - radius 3.0 metres

If the competitor steps outside this 3.0 metre "Penalty Circle", the manoeuvre will score ZERO.

- 3) The flying area circle - radius 26 metres

This is the extent of the flying area when a model aircraft using the longest lines is flown from the edge of the penalty circle.

- 4) The safety area circle - radius 29 metres

This is the area defined as item (3) above plus a further all round safety zone of 3 metres width.

In addition, contest organisers should provide a minimum of 1 (ideally 2) "Ready Boxes", plus 1 "Exit Box", all immediately adjacent to the flying circle. All these Boxes should, like the flying circle itself, be clearly separated from access by the general public, and each of these Boxes should be clearly marked on the ground and have sufficient length for 1 model aircraft complete with full length lines attached.

See picture:

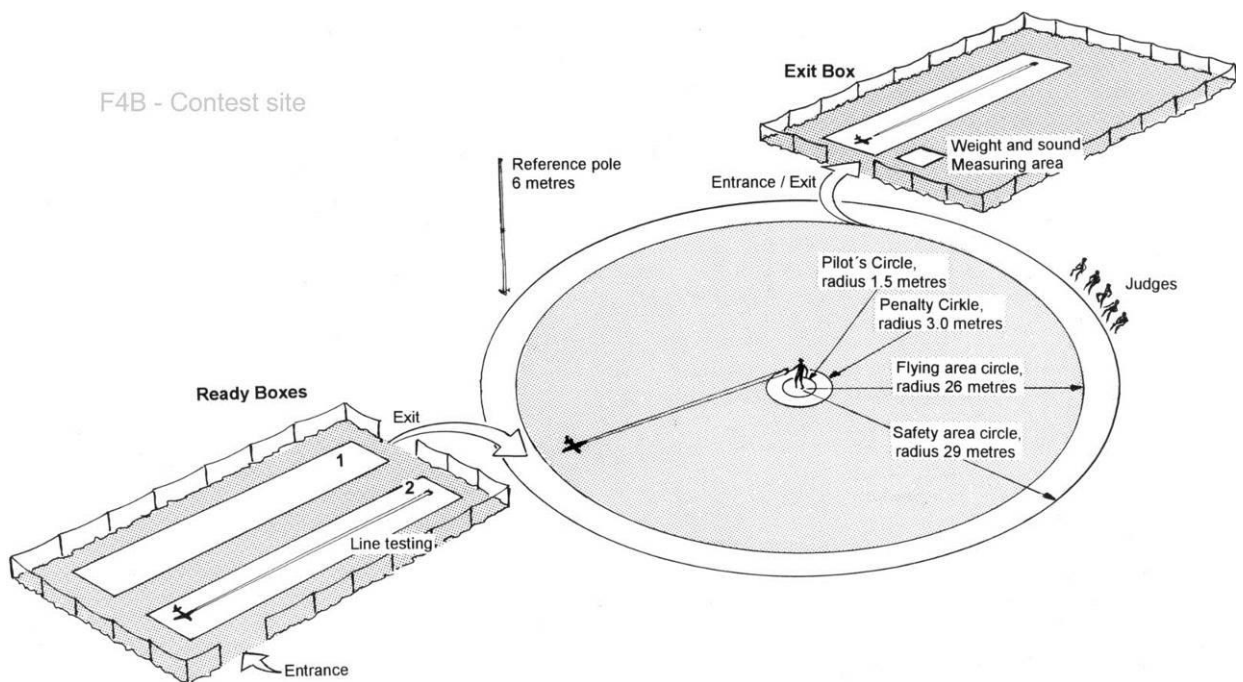

### 6.3. CLASS F4C - RADIO CONTROLLED FLYING SCALE MODEL AIRCRAFT

#### 6.3.1. General Characteristics

Maximum weight of the complete model aircraft without fuel in flying condition including any dummy pilot: 15 kg (≈150 Newton)

Model aircraft using electric motors as a power source shall be weighed without batteries used for those motors.

Motive Power: Rocket or pulse jet engines may not be used.

Radio Equipment:

Permitted:

The use of electronic stability augmentation devices or gyros with or without speed related automatic gain control derived from a GPS signal.

The transmission of information from the model aircraft to the pilot on the ground of Propulsion and Receiver system health monitoring. Any other data stream or telemetry is forbidden.

Not Permitted:

The use of autonomous or pre-programmed flight manoeuvres using sensors which provide altitude, heading or speed hold or any type of terrestrial reference (e.g.GPS).

Note: For all other scale model aircraft specifications see Volume *General Rules*, Section B, Paragraph B.1.3 General Characteristics of Model Aircraft.

#### 6.3.2. Noise

If a model aircraft appears to be noisy in flight, the Chief Judge or Flightline Director can demand a noise test. The transmitter and the model aircraft will then be impounded by the flightline official immediately following the flight. No modification or adjustment to the model aircraft shall be permitted other than refuelling. If the model aircraft features variable pitch propeller(s), the noise test will cover the total variation of pitch. The model aircraft shall be tested by a noise steward and in the event the model aircraft failing the noise test it will be re-tested by a second noise steward, using a second noise meter. If the model aircraft also fails the re-test, the score for the preceding flight shall be zero. This is a final decision. The sound meters must be of good quality with a test system (reference noise).

The maximum noise level will be 96 dB(A) measured at 3 metres from the centre line of the model aircraft with the model aircraft placed on the ground, over concrete or macadam, at the flying site. With the engine running at full power, measurement will be taken 90 degrees to the flight path on the side chosen by the competitor and downwind from the model aircraft. The microphone will be placed on a stand 30 cm above the ground in line with the engine(s). No noise reflecting objects shall be nearer than 3 metres to the model aircraft or the microphone. If a concrete or macadam surface is not available then the measurement may be taken over bare earth or very short grass, in which case the maximum noise level will be 94 dB(A). In the case of multi-engine model aircraft, the noise measurement will be taken at 3 metres from the closest engine to the noise meter and the maximum noise level will be the same as for single engine model aircraft. Turbine engines will not be subject to noise measurement.

#### 6.3.3. Official Flights

- a) Each competitor will be called to fly three rounds, and must execute an official flight within the required time limit (see 6.3.4.) on each occasion to be eligible for flight points for that flight.  
In the case of two flightlines (see 6.1.4) each competitor will fly four rounds, two in front of each panel of judges and two on each flight line and the lower score from each panel will be deleted.
- b) If a competitor is unable to start or complete a flight and, in the opinion of the Contest/Flightline Director, the cause is outside the control of the competitor, the Contest/Flightline Director may, at his discretion, award the competitor a reflight. The Contest Director shall decide when the reflight shall take place.
- c) An official flight commences at the earliest of the following:
  - i) The competitor signals to the timekeeper that he is commencing to start his engine(s).
  - ii) Two minutes after the competitor is instructed to start his flight.
  - iii) An official flight is terminated when the model aircraft lands and stops, except during the option 6.3.7.M. (Touch and Go).

**6.3.4. Flying Time**

- a) A competitor will be advised that he will be required to start his flight not less than 5 minutes before the instruction to start.
- b) The competitor will then be instructed to start his flight.
- c) Timing of the flight will commence when the official flight commences (see 6.3.3.c.).
- d) The competitor will be allowed 17 minutes to complete his flight.
- e) In the case of a multi-engined model aircraft, the time allowed in (d) above will be increased by one minute for each additional engine.
- f) No points will be awarded for any manoeuvre that is not completed at the end of the time allowed.

**6.3.5. Starting Time**

- a) If the model aircraft is not airborne within 7 minutes, plus one additional minute for each extra engine, after the official flight and timing commence, the official flight will end and no points will be awarded for the flight.
- b) If the engine(s) stops after the take-off has commenced, but before the model aircraft is airborne, the engine(s) may be restarted. There is only one attempt allowed to repeat the whole procedure. In the case of a repeated attempt, no points will be assigned for the interrupted manoeuvre.

Note: In this case rule 6.3.5(a) still applies.

**6.3.6. Flight**

6.3.6.1. Take-off .....	K = 11
6.3.6.2. Option 1 .....	K = 7
6.3.6.3. Option 2 .....	K = 7
6.3.6.4. Option 3 .....	K = 7
6.3.6.5. Option 4 .....	K = 7
6.3.6.6. Option 5 .....	K = 7
6.3.6.7. Option 6 .....	K = 7
6.3.6.8. Option 7 .....	K = 7
6.3.6.9. Option 8 .....	K = 7
6.3.6.10. Approach and Landing .....	K = 11
6.3.6.11. Realism in flight	
a) Flight Presentation .....	K = 4
b) Speed of the model aircraft.....	K = 9
c) Smoothness of flight.....	K = 9
Total K Factor .....	K = 100

Notes: The flight schedule must include the two manoeuvres “Figure Eight” and “Descending 360° Circle” to be accepted as complete.

The scale of the model aircraft and the cruising or maximum speed of the prototype must be stated on the example Flight Score Sheet (Annex 6E.2.)

Only one attempt is permitted for each manoeuvre, the only exception is the procedure of getting a model aircraft airborne, as defined in 6.3.5.b.

**6.3.7. Optional Demonstrations**

The manoeuvres “Figure Eight” and “Descending 360° Circle” are mandatory manoeuvres to be included in each flight and positioned in the flight schedule at the competitor’s discretion.

Competitors must be prepared, if required by the judges, to give evidence that the options selected are typical and within the normal capabilities of the aircraft subject type modelled.

Only one manoeuvre involving the demonstration of a mechanical function may be included in a competitor’s choice of options. These include (options D (Bombs/Fuel Tank Drop), O (Parachute Drop), and, if applicable, S or T (Flight Functions by subject aircraft).

The options may be flown in any order, but the order must be indicated on the score sheet and be given to the judges before commencing the flight.

A competitor may not select option “C” (Retract and extend flaps) if option “B” (Retract and extend landing gear) has also been selected.

The order in which all manoeuvres are to be flown must be marked on the score sheet and any manoeuvre flown out of order will be marked zero.

A	Chandelle .....	K = 7
B	Retract and extend landing gear .....	K = 7
C	Retract and extend flaps.....	K = 7
D	Dropping of bombs or fuel tanks.....	K = 7
E	Stall turn.....	K = 7
F	Immelmann turn .....	K = 7
G	One loop .....	K = 7
H	Cuban Eight .....	K = 7
I	Reverse Cuban Eight .....	K = 7
J	Half Cuban Eight .....	K = 7
K	Half Reverse Cuban Eight .....	K = 7
L	Split S (Reversal) .....	K = 7
M	Normal spin (three turns) .....	K = 7
N	Roll .....	K = 7
O	Parachute .....	K = 7
P	Touch and go.....	K = 7
Q	Overshoot .....	K = 7
R	Side slip to left or right .....	K = 7
S	1 <sup>st</sup> Flight function by subject aircraft .....	K = 7
T	2 <sup>nd</sup> Flight function by subject aircraft .....	K = 7

*Competitors may demonstrate up to two different flight functions of their own choice, but must supply evidence that each function was performed by the prototype modelled. Competitors must indicate on the declaration form and to the Chief Flight Judge the nature of the demonstration(s) before going to the flight line).*

U	Flight in triangular circuit.....	K = 7
V	Flight in rectangular circuit .....	K = 7
W	Flight in a straight line at constant height (maximum height 6 metres) .....	K = 7
X	Flight in a straight line with one engine throttled (for multi-engined model aircraft only) .....	K = 7
Y	Lazy Eight .....	K = 7
Z	Wingover.....	K = 7
AA	Inverted flight.....	K = 7
AB	Derry Turn .....	K = 7
AC	Procedure Turn .....	K = 7
AD	Straight flight at low speed .....	K = 7

**6.3.8. Marking (flight points)**

Each manoeuvre will be awarded marks from 0 to 10, using increments of half a mark, by each of the judges during the flight. These marks are multiplied by the appropriate K - factor in each case.

The manoeuvres must be performed in a plane and at a height that will allow them to be seen clearly by the judges. The non-observance of this rule will be penalised by loss of points.

**6.3.9. Flight Score**

All flight scores will be recorded on the score sheet. It is the competitor's responsibility to ensure that his personal details, the details of the model and the chosen options are correctly entered on the score sheet and that sufficient copies are presented to the judges before each official flight commences.

The scores of all three judges will count towards the final score.

The flight score shall be the sum of the points awarded by all three judges in 6.3.6.

cont/...

Normalisation:

The total flight score of each competitor for each round will be normalised to 1000 points as follows:

$$\text{Flight Points}_x = F_x/F_w \times 1000$$

Where:

Flight Points<sub>x</sub> = Normalised Flight Score for competitor x

F<sub>x</sub> = Flight Score for competitor x and

F<sub>w</sub> = Highest Flight Score

#### **6.3.10. Final Scoring:**

For each competitor, add the normalised static score earned in 6.1.10. to the average of the normalised scores of the two best flights under 6.3.9. If the competitor has achieved only one flight, the normalised score awarded for that flight will be divided by two.

If for any cause beyond the control of the organisers (eg. B.11.1.) less than three official rounds can be flown, the scoring shall be completed as follows:

- a) If two rounds are flown, the average of the normalised scores of the two flights as in 6.3.9. will be used.
- b) If only one round is flown, the single normalised flight score of that one round will be recorded.
- c) The scores in an official round can be recorded only if all competitors had equal opportunity for a flight in that round.

The national team classification for World or Continental Championships is established after the completion of the championship by adding the scores of the three members of the team together unless there is a fourth member of the team (who must always be a junior) in which case it will be the three best scoring members.

In the case of a national team tie, the team with the lower sum of place numbers, given in order from the top, wins. If still equal, the best individual placing decides.

#### **6.3.11. Safety:**

- a) All manoeuvres must be performed parallel with the judges' line such that if any part of the manoeuvre is performed behind the judges' line it will score ZERO.
- b) Exceptions from this rule are manoeuvres 6.3.1. Take-off, 6.3.6.10 Landing, and 6.3.7.m. Touch and Go. These manoeuvres have the right to be performed into wind as long as they do not overfly a designated area behind the judges' line laid out for the protection of spectators, officials and other competitors or helpers.
- c) If a model aircraft is in the opinion of the Chief Judge or Flightline Director unsafe, or being flown in an unsafe manner, he may instruct the pilot to land.

**6.9. CLASS F4H - RADIO CONTROLLED STAND-OFF SCALE AEROPLANES****6.9.1 General Characteristics**

The General Characteristics of the model shall be the same as F4C. (Para 6.3 refers).

**6.9.2. Eligibility**

Any model which has previously been placed in the top five (5) in a Continental or World Championship F4C competition during the last 6 years, including repaints and rebuilds, will NOT be permitted in F4H. The requirement for the competitor to have constructed his own model (rule 6.1.9.4.e) is not applicable to Stand-Off Scale; however the surface finish (colour and markings) on the model must have been applied by the competitor.

**6.9.3 Declaration**

The competitor must complete and sign the Declaration Form at ANNEX 6E.1 certifying that he has applied the surface finish (colour and markings) to the model. The declaration also includes a questionnaire which is used by the Static Judges to assess how much the competitor contributed to the Scale Accuracy. If an incorrect declaration is subsequently revealed, the competitor may be disqualified from the contest. The competitor may also use photographs or sample material in support of the declaration.

Note: The declaration must be consigned by the Competitor's NAC to be valid.

**6.9.4 Static Judging**

- a) The appointment of Static Judges is stated in 6.1.4. The final static score shall be the sum of the individual judge's marks.
- b) All static judging is carried out at a distance of 5 metres. This is measured from the centre line of the model to the judges seating position.
- c) Each of the following items will be awarded a mark out of 10 by each Judge using increments of a tenth of a mark.

**6.9.4.1 Scale Accuracy.**

This an assessment of the outline accuracy of the model compared with the prototype as seen from three aspects (side, front and top plan), judged by comparison with the documentation presented.

**6.9.4.2 Originality of Model Design & Construction**

This is an assessment of the extent to which the scale accuracy of the model is due to the effort of the competitor. Maximum marks will be awarded to a model which is constructed in its entirety by the competitor (Own design, from drawings or a traditional kit). A model which is built from a modern kit might score a little less, depending upon the extent of prefabrication. An ARTF model will score close to zero (unless evidence is presented of extensive modification by the competitor).

**6.9.4.3 Colour and Markings Accuracy**

This is an assessment of the accuracy of the colour and markings of the model by comparison with the documentation presented.

**6.9.4.4 Colour and Markings complexity**

This is a subjective assessment of the difficulty in reproducing and applying the finish and markings to the model.

**6.9.4.5 Realism**

This is a subjective assessment of how well the model captures the character of the prototype as illustrated by the documentation; taking into account the surface finish, weathering and any detail that is noticeable at 5 m.

**6.9.5 Static Judging**

<b>Item</b>	<b>K-factor</b>
Scale Accuracy	
Side view	K= 13
Front view	K= 13
Top view	K= 13
Colour	
Accuracy	K= 7
Complexity	K= 3

**Markings**

Accuracy	K= 10
Complexity	K= 5
Realism	K= 16
Originality of Model Design & Construction	K= 20
Total	K= 100

**Normalisation:**

The total of the competitors' static scores will be normalised to 500 points as follows:

$$\text{Static Points}_x = S_x/S_w \times 500$$

Where:

Static Points<sub>x</sub> = Normalised Static Score for competitor x

S<sub>x</sub> = Static Score for competitor x and

S<sub>w</sub> = Highest Static Score

**6.9.6 Documentation**

- The documentation requirement is the minimum considered necessary to fully assess the outline from 3 aspects, the colour, the markings and the realism. As with all scale aeroplanes static judging, good photographs are the prime means of judging scale accuracy. Photographs and reproductions should be of a reasonable size, (approximate A5 minimum) and presented on separate sheets or as a montage no larger than A2. A book with page markers is not acceptable.
- There are no prescribed penalties for missing or inadequate documentation, but judges can only award marks on the basis of the documentation available. Poor documentation will be reflected in reduced scores and any item of static judging for which there is no documentation will result in a Zero score for that item.

**6.9.6.1 Photographic evidence:**

A minimum of one (1) photograph or printed reproductions and a maximum of five (5) photographs or printed reproductions of the prototype, one or more of which must show the actual subject aircraft being modelled. At least one photograph must show the whole aircraft. Photographs of the model are not permitted unless it is posed alongside the full size prototype modelled for proof of colour. Photographs which show evidence of digital manipulation shall result in disqualification. There is no requirement for close up or detailed photographs, but additional photographs (within the maximum of 5 total) can be used to support the three aspects if the outline needs clarification.

**6.9.6.2 Drawings:**

Three view drawings are required and will be used by the judge as the basis for judging outlines. Drawings must conform to the requirements of rule 6.1.9.4(b). Photographs take precedence when discrepancies exist between the drawings and the chosen subject.

**6.9.6.3 Proof of colour and markings:**

This may be in the form of colour chips or original paint samples, colour photographs (which may be the same photos supplied for outline), or colour illustrations published in books, magazines or on kit boxes. Published descriptions are also acceptable when accompanied by examples of similar colours used on other aircraft types. Authenticated colour chips will not be a requirement for proof of colour.

**6.9.7 Flying Schedule**

The Flying Schedule shall be the same as F4C (Paragraph 6.3. refers)

**Normalisation:**

The total flight score of each competitor for each round will be normalised to 1000 points as follows:

$$\text{Flight Points}_x = F_x/F_w \times 1000$$

Where:

Flight Points<sub>x</sub> = Normalised Flight Score for competitor x

F<sub>x</sub> = Flight Score for competitor x and

F<sub>w</sub> = Highest Flight Score

### 6.9.8 Final Scoring

For each competitor, add the normalised static score earned in 6.9.5 to the average of the normalised scores of the two best flights under 6.9.7. If the competitor has achieved only one flight, the normalised score awarded for that flight will be divided by two.

If for any cause beyond the control of the organisers (eg. B.11.1.) less than three official rounds can be flown, the scoring shall be completed as follows:

- a) If two rounds are flown, the average of the normalised scores of the two flights as in 6.3.9. will be used.
- b) If only one round is flown, the single normalised flight score of that one round will be recorded.
- c) The scores in an official round can be recorded only if all competitors had equal opportunity for a flight in that round.

The national team classification for World or Continental Championships is established after the completion of the championship by adding the scores of the three members of the team together unless there is a fourth member of the team (who must always be a junior) in which case it will be the three best scoring members.

In the case of a national team tie, the team with the lower sum of place numbers, given in order from the top, wins. If still equal, the best individual placing decides.



**ANNEX 6A****CLASS F4B, C AND G JUDGES' GUIDE FOR STATIC JUDGING****6A.1 General**

- a) Before static judging commences the judges should review the whole entry in order that a standard be established for grading the points to be awarded. The entries should be studied in relationship to each other from a superficial aspect before detailed examination commences. The Chief Static Judge should take this opportunity to ensure that all judges are of a similar mind as to what is involved, particularly with respect to complexity aspects where these are applicable.
- b) A trial assessment using one or more non-competition model aircraft should be done prior to the start of the competition to establish a uniform standard.
- c) A Chief Judge shall be appointed as a spokesman for the static judges, and if two panels of static judges are to be used, the second panel will have a Deputy Chief Judge appointed to assist the Chief Judge in his work. The Chief/Deputy Chief Judge should discuss the merits and criticisms of each item in his responsible area with the other judges in his team, asking for suggestions for the scores.
- d) The static evaluation is broken down into six items as listed in 6.1.10. Judges must discuss each item as a team and attempt to arrive at a unanimously agreed score for each item, although each will retain the right to differ. Any degree of difference should however be minimal.
- e) The chief judge should discuss the merits and criticisms of each item with the other judges, asking for suggestions for the scores to be awarded as a basis for further discussion. Where a K-factor (K) is noted, marks shall be awarded from 0 to 10 inclusive using increments of a tenth of a mark for Static Judging. The score shall then be calculated by multiplying the marks awarded by the K-factor (K) (see 6.1.5.). The use of increments is important when judging top-class model aircraft. There may be instances where, for example, a 9 would be too low and a 10 too high, and a suitable score might be, say, 9.5.
- f) Regardless of the actual marks awarded, it is imperative that an accurate and fair comparison is attained across the whole range of model aircraft entered. The relative mark of one model aircraft compared to another is the most important standard to be achieved. Judges are encouraged to make use of analysis sheets and electronic or other archive devices to achieve this comparison.
- g) Upon the completion of the static judging of each model aircraft, the chief judge must check all score cards for completeness before submitting them for processing. The panel of judges has the right to alter scores retrospectively that they subsequently feel to be wrong (eg first model aircraft deviations, details not proven by documentation, over-looked commercial items). Sufficient time must be allocated by the organisers for this review to be done. Only when the Chief Judge agrees that this has been achieved should the scores be released for publication.
- h) If model aircraft are flown before being static judged (see 6.1.3.), any damage sustained during flight shall be ignored by the static judges provided the model aircraft is intact and it is practical to do so.

**6A.1.9. Documentation for Proof of Scale**

The minimum documentation as stated in 6.1.9.4. must be provided. Failure to comply shall result in penalty marks as follows:

- |  |                                       |            |
|--|---------------------------------------|------------|
| a) Less than 3 full photos of prototype: | ZERO points for Scale Accuracy        | (6.1.10.1) |
|  | Possible downmarking of Realism       | (6.1.10.4) |
|  | Possible downmarking of Craftsmanship | (6.1.10.5) |
|  | Possible downmarking of Scale Detail  | (6.1.10.6) |
| b) Missing or unauthorised drawings:     | ZERO points for Scale Accuracy        | (6.1.10.1) |
| c) No photo of subject aircraft:         | ZERO points for markings              | (6.1.10.2) |
|  | Possible downmarking for Realism      | (6.1.10.4) |
|  | Possible downmarking of Scale Details | (6.1.10.6) |
| d) Incomplete colour documentation:      | ZERO points for Colour                | (6.1.10.3) |

The documentation stated above is the absolute minimum required for participation. In reality more comprehensive evidence is needed to assess the model aircraft relative to the prototype. As the full size aircraft cannot be presented it follows that the photographic documentation provided should be as comprehensive as possible if a high score is to be achieved.

All documentation should relate to the subject aircraft whenever possible; variations from this must be clearly marked if not otherwise obvious. All relevant notes and corrections to the documentation should be in English.

The static judges have a difficult task to do in a short period of time. Documentation should therefore be presented in a format that can be quickly and accurately assessed. Superfluous or contradictory evidence should be avoided. The documentation must be presented as a top hinged bound volume in landscape format (calendar format) with a maximum size of A3. The sequence of pages must reflect the sequence of judging aspects eg: Side View, Front View, etc. If a specific photograph is required to document more than one of the judging aspects, it must be repeated on the relevant page to avoid that the judges have to continually turn pages back and forth to cross reference.

#### **6A.1.10. Static Judging**

Items 6.1.10.1. must be judged at a minimum distance of 3 metres in F4B and 5 metres in F4C from the centre of the model aircraft. A handler should be prepared to position the model aircraft as directed by the judges. No measurements are to be taken and the model aircraft must not be handled by the judges.

The model aircraft must be judged against the documents presented and judges should award marks solely on this evidence. The quality of the documentation/evidence provided by the competitor will normally be reflected in the score that the judges award. Accurate and clear evidence deserves good marks if the model aircraft matches this. Judges must ensure that a competitor does not benefit by default by submitting poor or incomplete documentation.

Judges must assess both accuracy and complexity in those aspects where indicated.

#### **6A.1.10.1. Scale Drawings**

The drawings and the photographs are used to determine the accuracy of the model relative to the full size aircraft.

Then using the drawings and photographs, check:

Side view, this may be either left or right depending upon the drawings supplied. A check should be made of the fuselage outline, cabin or canopy shape, cockpit aperture shape, engine cowling and spinner shape, outline of fin and rudder, wing and tailplane sections. Also the shape, angle and position of landing gear legs and tail wheel or skid, the size of wheels and tyres. On multi-wing aircraft a check should be made of wing stagger, wing gap and the shape and arrangement of struts and incidence wires.

Front-end view, for dihedral, wing thickness and taper, wing struts, bracing and gap on multi-wing aircraft. Also the thickness of fin, rudder and tailplane, cross-sections of fuselage and engine cowling, cowling shape and cutouts, propeller size and shape, shape of cockpit canopy or windshields; size, shape, position and angle of landing gear, wheel track, tyre thickness.

Upper-Plan view for wing outline and fairings, aileron size, flaps; tailplane size and outline; elevator size, shape and cut outs, trim tabs, fuselage shape and taper, cockpit or canopy shape, engine cowling shape.

#### **6A.1.10.2. Colour**

##### Colour Accuracy:

Correct colour may be established from colour photographs, from accepted published descriptions if accompanied by colour chips certified by competent authority, from samples of original paint, or from accepted published colour drawings. Also check colours of national markings, lettering and insignia. Camouflage colour schemes should show the correct degree of merging of the shades.

##### Colour Complexity:

Consideration should be given to the greater effort involved in reproducing multi-coloured finishes compared to model aircraft which feature only one or two basic colours. The system for awarding colour complexity points should be agreed before starting competitive judging. Up to two complexity points may be given for each main colour that covers a significant part of the airframe.

A maximum of a single point may be given for each minor colour, such as those for the insignia, struts, guns, bombs etc. Basic colours of black and white should attract a fraction of a complexity point. It is again essential that if high marks are to be awarded, a comprehensive standard of colour documentation must be presented.

**6A.1.10.3. Markings**

If just a single panel of 3 judges is involved, much of the Markings aspect can be assessed whilst checking scale accuracy. The relative positioning and shape of the markings on the model are often a good indication of scale accuracy as they highlight errors in shape and outline. The opportunity to check markings on the underside of the model can also be taken whilst checking the plan view.

Markings Accuracy:

Check the position and size of all markings and lettering. Particular emphasis should be made to the relative positioning of markings to other markings and key features on the airframe. Check that the style and thickness of all letters and figures are correct. Check that any trim strips are of the correct dimensions and are correctly positioned. Check camouflage patterns.

Markings Complexity:

Prior to commencing the competition the judges should agree the principle for awarding complexity points in relation to markings. A high mark for complexity is not solely dependent upon the number of markings, but the difficulty in achieving the required effect. Complex lettering, particularly when spread over a large area or relating to key positions on the airframe, should attract a higher complexity mark than sparsely positioned markings of more simple design. Curved lines are usually more complex than straight lines. Camouflage patterns should be considered carefully, with the more complex styles involving irregular patterns and indistinct edges being rewarded accordingly. For high marks to be given in this section it is important that documentation is presented covering all the markings to be assessed.

**6A.1.10.4 Surface Texture and Realism**

The texture and appearance of the surface of the model aircraft should be a good reproduction of that of the prototype. Fabric covered types should be covered in the correct material, and the outline of stringers and wing ribs should be visible. Ply covered or wooden monocoque types should be correctly simulated and any sag between the ribs and formers should be apparent if this is present on the prototype. Metal stressed skin types should show simulation of panels and rivets. In all instances, the appropriate gloss, or matt finish should be correctly reproduced.

Realism is a question of how well the model aircraft captures the character of the full size aircraft. The judges should ask themselves if they are looking at the subject aircraft in miniature, or just a model aeroplane.

If the subject aircraft is an unblemished museum example then the model aircraft should be in similar pristine condition. If the subject aircraft is an operational aircraft then a degree of weathering and signs of regular use should be evident if appropriate to the full size machine.

The documentation should show these aspects and the judges should mark accordingly.

**6A.1.10.5. Craftsmanship**

This section deals with the skill, ingenuity, general finesse and complexity involved in the construction of the model aircraft.

Craftsmanship Quality:

The model aircraft should be checked for quality of workmanship, with particular reference to clean, sharp edges, especially trailing edges of wings and tail surfaces; correct gaps at hinge line of control surfaces; close fit where non-scale joints are used for dismantling the model aircraft or access hatches used for model aircraft operation.

Non-scale items such as switches, needle valves, silencers, control horns, etc should not be visible.

Craftsmanship Complexity:

Judges should consider the overall complexity of the design awarding higher marks for more intricate shapes and structure. Special items of ingenuity may also be rewarded under this section.

In assessing both the above aspects judges should consult the competitor's declaration and check for any components that have not been made by the competitor (see 6.1.9.4e) and adjust the marks awarded accordingly.

The points that are awarded must again reflect the standard of documentation presented.

**6A.1.10.6. Scale Detail**

Check that items such as those listed are present on the model aircraft where applicable, and that they are accurately reproduced and correctly positioned.

Hatches	Brake pipes
Handles	Landing gear springing
Footsteps	Tyre treads
Doors	Wing slots
Armament	Navigation and landing lights
Bomb racks	Pilot head
Control cables	Walkways
Control horns	Tanks
Fairings	Radiators
Bracing	Filler caps
Turnbuckles	Louvres
Struts	Cooling gills
Lacing or stitching	Mass balances
Aerials	Instrument panel
Venturis	Cockpit or cabin interior detail

The points awarded should reflect both the accuracy and the quantity of scale detail present.

Scale Detail Accuracy:

The documentation presented should clearly show the features that are being assessed. Higher marks should be awarded to those competitors who accurately reproduce these items.

Scale Detail Complexity:

A well-documented highly detailed model aircraft should score proportionately more than a model aircraft with little detail, even if the full-size prototype is itself sparsely detailed. Judges should ensure when marking this aspect that they are relating to the complexity of detail actually on the model aircraft, not awarding marks for just what the prototype should have.

## ANNEX 6B

### CLASS F4B JUDGES' GUIDE - FLYING SCHEDULE

#### 6.B.1 General:

All flying manoeuvres must be judged bearing in mind the performance of the full size subject aircraft. The aim of the scale flight schedule is to recreate the flight characteristics and realism of the full-size aircraft within the limits of the control-lines. Judges must therefore not confuse scale F4B contests with aerobatics F2B contests.

The errors under each manoeuvre cannot be an exhaustive list of all possible faults. They are intended rather to show the sort of mistakes that are likely during the course of that manoeuvre. These errors examine each manoeuvre from three aspects:

1. The shape, size and technical requirements of the intended manoeuvre.
2. The positioning of the manoeuvre relative to the judges position or other datum.
3. How well the pilot is able to suppress the limiting factor of the control-lines yet still achieves scale realism in his flight.

It remains the responsibility of the judges to decide from their own experience on the importance of each error and deduct marks accordingly, always taking into account the characteristics of the full size aircraft

Each manoeuvre must be announced prior to commencement and called on commencement by the word "NOW". Completion of each manoeuvre must also be announced by the word "FINISHED". Failing to do so, loud and clear will result in loss of marks for that manoeuvre.

The judges will be seated outside the circumference of the contest circle in a position agreed by in concert between the Contest Director and judges. When the wind direction, in the opinion of the CD, continually deviates more than 30° from the first decided direction, the judges' position will be adjusted accordingly.

The pilot is permitted to choose the spots where he wishes to commence his take off run and terminate the roll out after landing. He is also free to choose where he wishes to position each manoeuvre, but must bear in mind that manoeuvres need to be positioned in full view of the judges to achieve a good score.

In the interest of safety, any manoeuvre that is carried out when the Competitor steps outside the 1.5 metre radius "Pilot's Circle" will carry a warning by the Circle Marshall to the Competitor, but no penalty. If the Competitor steps outside the 3.0 metre radius "Penalty Circle" the manoeuvre will score ZERO.

Before the flying part of the contest commences, normally done in conjunction with the static judging, there must be agreement between the Chief Judge and the respective team manager on the exact nature of manoeuvres M if such a manoeuvre is chosen by any competitor. There must be no such discussion at the flight circle.

The item 6.2.6.8. "Realism in Flight", should be discussed by all judges after completion of the flight and they should attempt to arrive at an agreed score for this item. At the end of each flight, the chief judge must check all score sheets for completeness.

After each flight, the Chief Judge will record any non-standard event that causes downgrading or loss of flight points. As examples: Missed figures, figures flown out of order, out of time, stepping outside the penalty circle, missing dummy pilot or crash landing, etc....

*cont/...*

**Definitions:**

Three basic levels of flight are defined:

- Low Flight Level at approximately 2 m height
- Normal Flight Level at approximately 6 m height
- High Flight Level between 30° and 45° line elevation

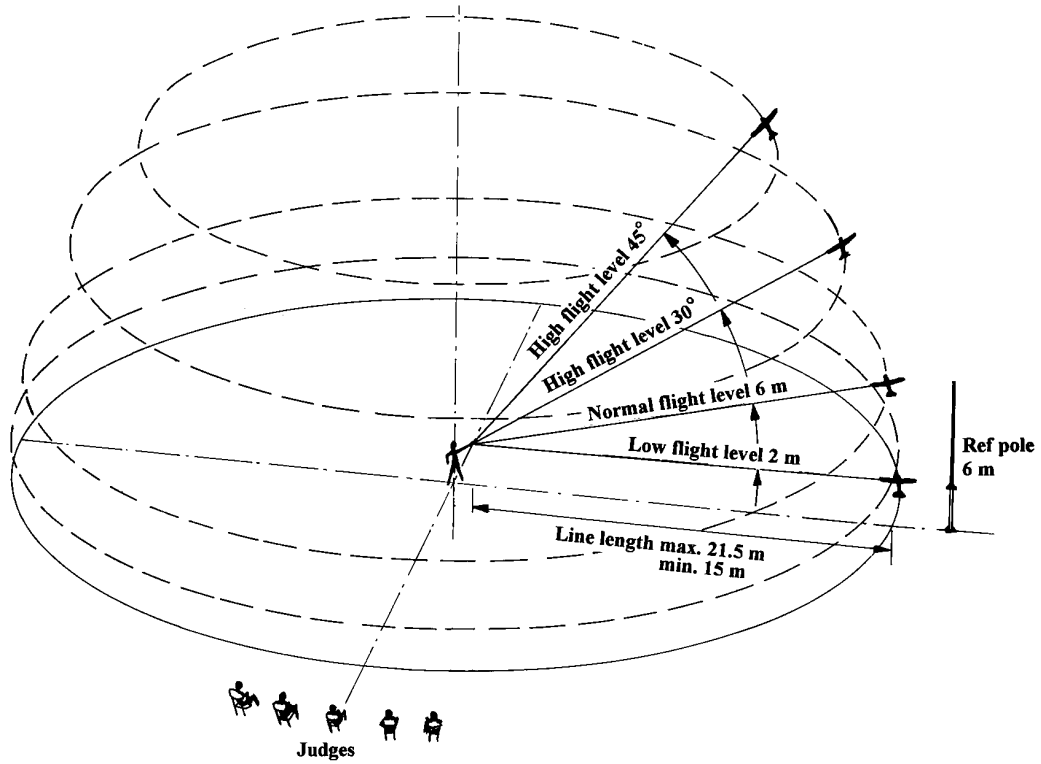

**6B.2.7.1. Taxi and Take-off:**

The model aircraft should taxi a minimum distance of 15 metres in a realistic manner and speed and finally come to a full stop. The model aircraft should stand still on the ground with the engine(s) running without being held. All engines must be operating for full marks. If the model aircraft is touched after the word "NOW" has been called the manoeuvre will score zero. The model aircraft should then accelerate to a realistic speed and lift smoothly from the ground, climb at an angle consistent with the subject aircraft and level off at Normal Flight Level. The manoeuvre may, depending of the subject aircraft, take more than one lap to finish.

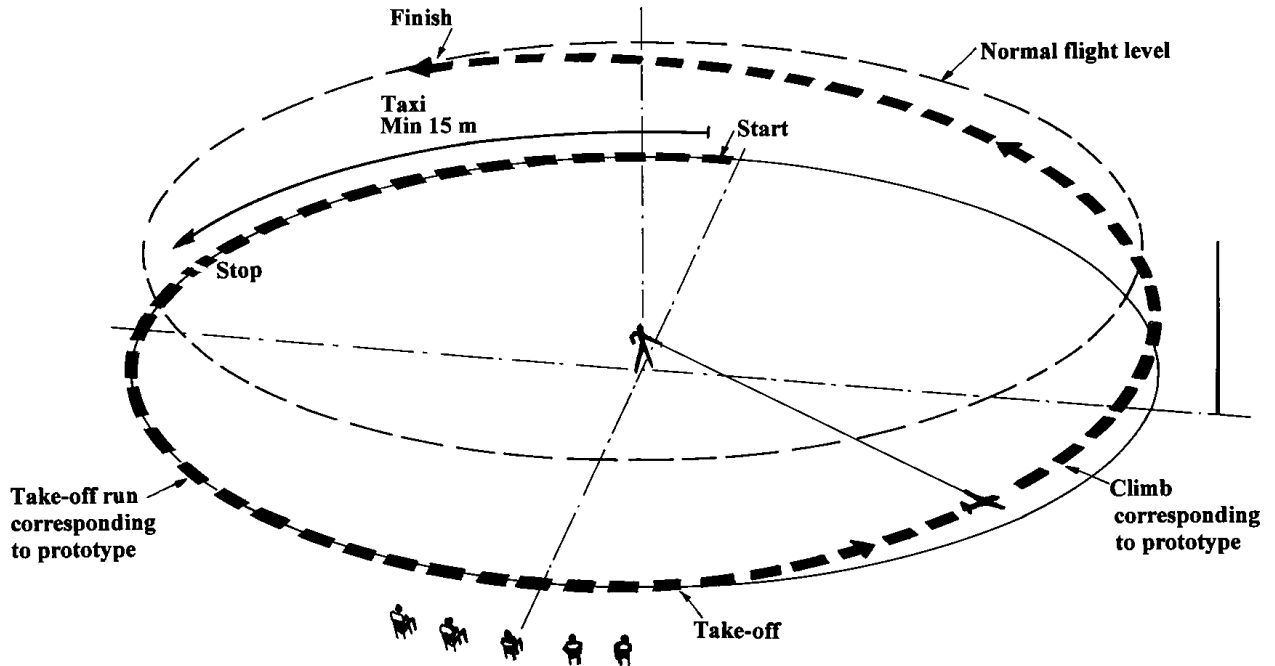
Errors:

1. Taxi not 15 metres.
2. Not a realistic taxi for the subject aircraft.
3. Not all engines operating.
4. If held or touched by anyone during the manoeuvre, the score is zero.
5. Model aircraft touched after calling "NOW" (zero marks).
6. Climb erratic.
7. Climb not consistent with subject aircraft.
8. Level off not smooth.
9. Level off not at Normal Flight Level.

### 6.B.2.6.2 Five laps at Normal Flight Level:

This manoeuvre should demonstrate the basic flying qualities of the model aircraft. Five smooth and stable laps should be flown at Normal Flight Level. Height should remain almost constant for optimum marks.

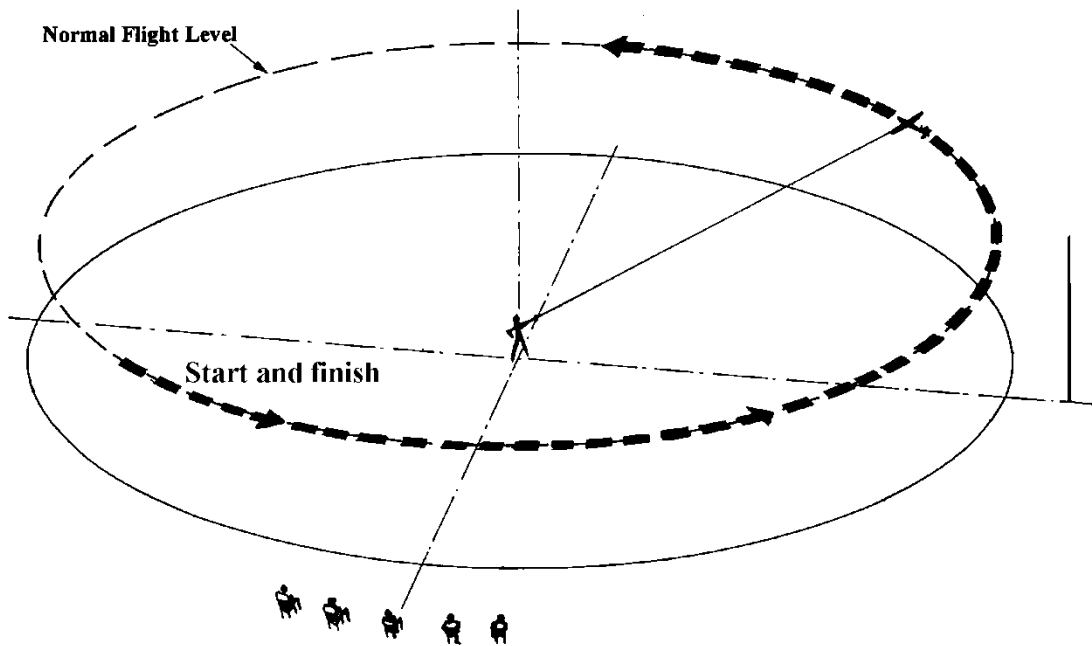

#### Errors:

1. Not five laps (zero marks). More than five laps is not an error.
2. Flight above or below Normal Flight Level (approx. 6 m) will downgrade the score proportionately.
3. Model aircraft flight path not smooth and steady.



**6.B.2.7. Optional Demonstrations – General**

The selection of manoeuvres and the order in which they are to be flown must be shown on the score sheet and given to the judges before each flight. This order must be adhered to and any manoeuvre flown out of sequence will score zero.

**A Multi-engines:**

In order to qualify for full multi-engine points, all engines must run for the complete flight. Should any engine cut prematurely, then the mark will be reduced accordingly.

**B Retract and Extend Landing Gear:****C Extend and Retract Flaps:**

(Diagram and errors applicable to both manoeuvres unless stated)

The manoeuvre should commence from Normal Flight Level and be flown with the gear/flaps fully extended at Low Flight Level (approx. 2m) for at least three consecutive laps. The gear/flaps will then be retracted during a climb out to Normal Flight Level where the manoeuvre is finished.

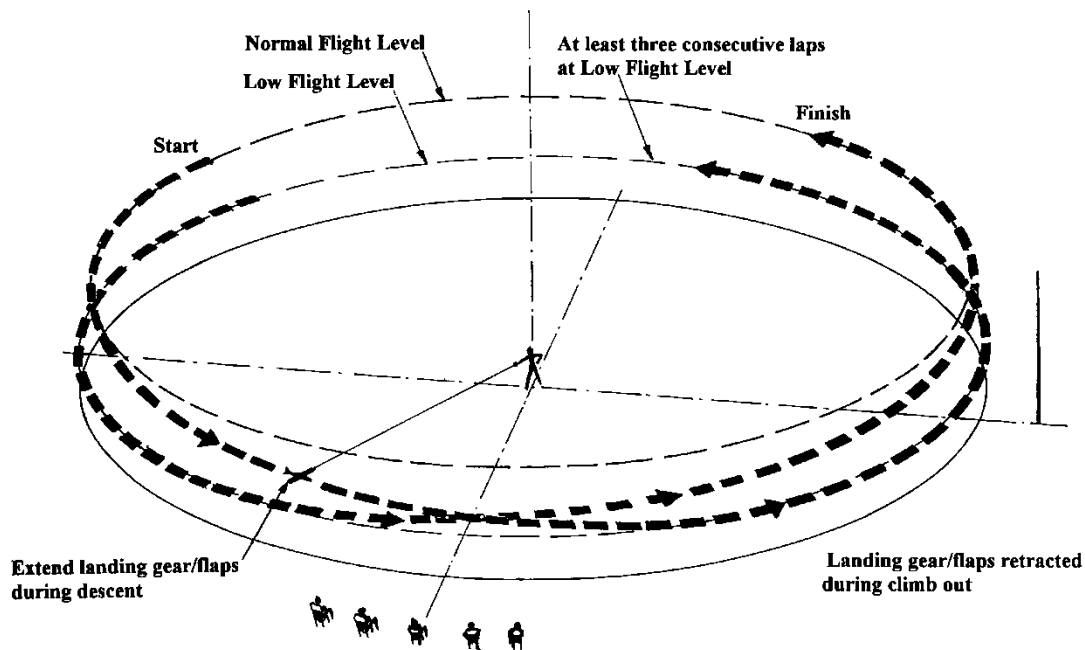
**Errors:**

1. Not commenced from Normal Flight Level.
2. Extension and or retraction not in full view of the judges.
3. Model aircraft speed too high for landing gear/flap lowering.
4. Model aircraft not flown at Low Flight Level for three consecutive laps with gear or flaps extended.
5. Speed and or sequence of extension and retraction not realistic.
6. No change in attitude with flaps lowered.
7. Manoeuvre not finished at Normal Flight Level.

**D Dropping of Bombs or Fuel Tanks:**

If bombs are carried internally, bomb-bay doors must be open and be closed after the drop. If bombs or fuel tanks are carried externally, they must be fitted in the correct position and in the correct manner. Dropping should be in the manner of the prototype. The dropping zone shall be positioned in front of the judges as a circle with the radius of five (5) meters and shall be clearly marked on the ground with paint or tape. Any special features of the manoeuvre should be declared to the Judges beforehand.

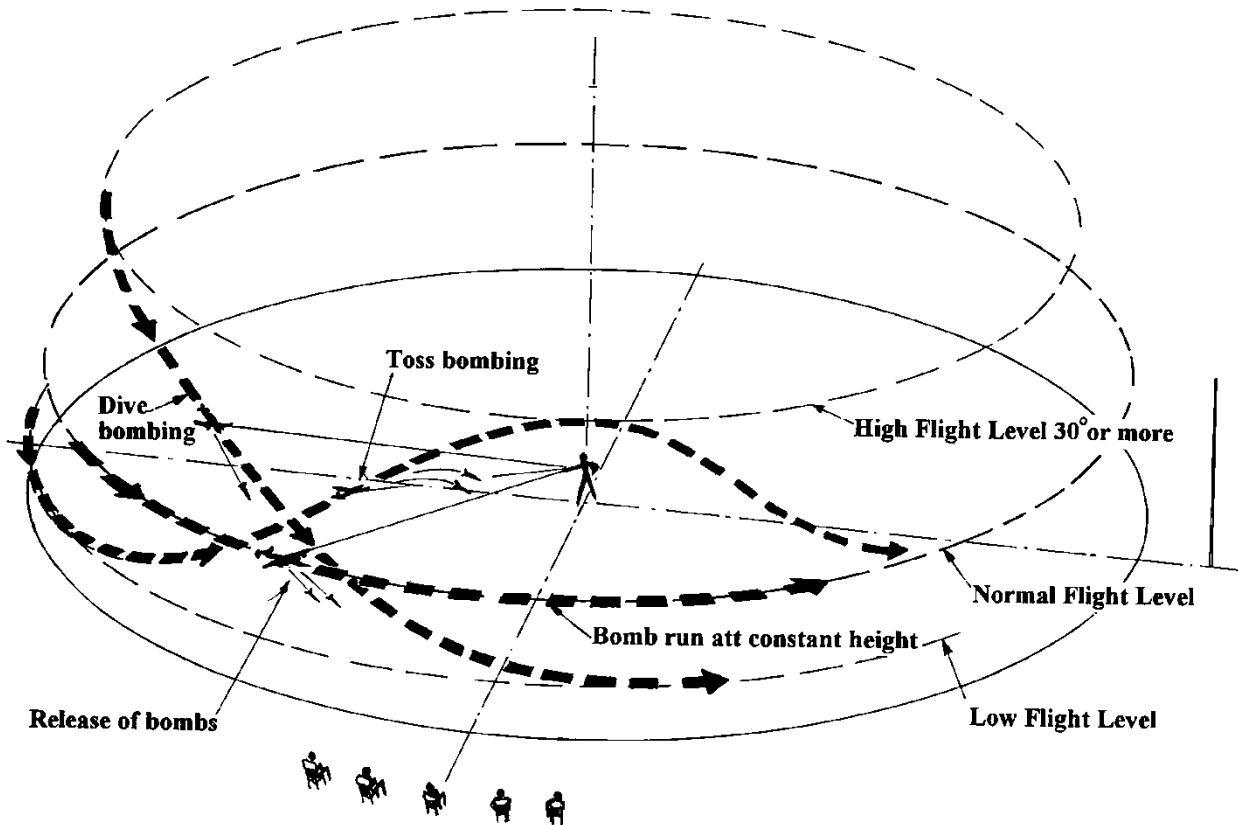
**Errors:**

1. Not a realistic way of releasing the bomb load.
2. Bomb bay doors did not operate in a realistic way.
3. Bombs do not behave as such on falling to their target zone
4. Bombs not falling on the intended and agreed area.
5. Drop tanks not behaving as drop tanks in the air.

**E High Flight At Over 30° Line Angle:**

During three complete and consecutive laps the lines must be at a minimum angle of 30° to the ground. The centre of the circles, which the model aircraft describes, must be directly over the flier's head.

Optimum marks will be awarded if the lines do not come below 45° and the flight level must remain almost constant. Lower marks will be awarded to model aircraft that fly below 45° but above 30°, or if the flight level changes considerably during the three laps. Zero marks shall be given if the model aircraft flies below 30° line-angle at any moment during the three laps.

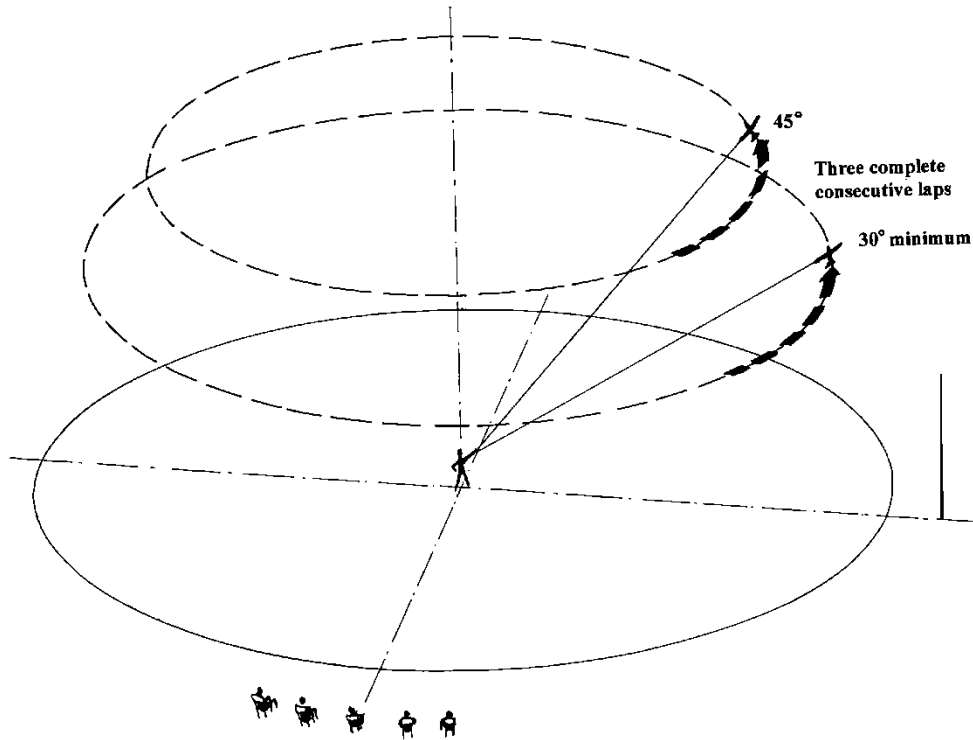
**Errors:**

1. Not three consecutive laps.
2. Not between 30° and 45° line angle.
3. Great variations of height during the flight.
4. Centring varies during the flight.
5. Below 30° line-angle, at any moment, zero marks.

**F One Inside Loop:**

From Low Flight Level, the model aircraft pulls up into a circular loop and resumes level flight at the same height as the entry. The throttle may be reduced at the top of the loop, as the subject aircraft would be operated. Low powered aircraft types would be expected to execute a shallow dive at full throttle in order to pick up speed before commencing the loop.

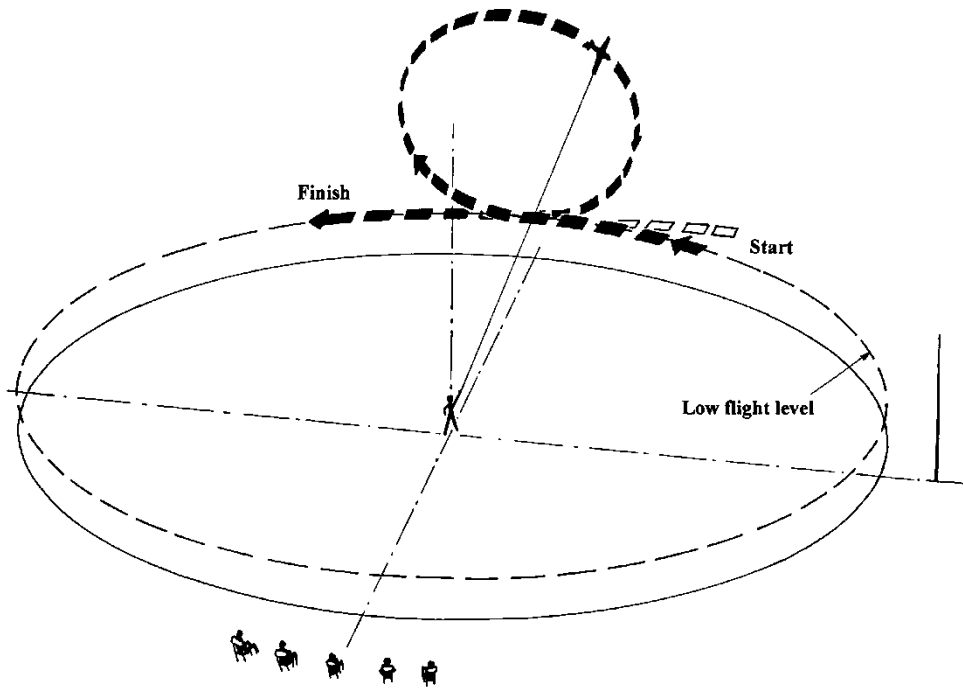
**Errors:**

1. Loop not commenced at Low Level Flight.
2. Track of loop not vertical.
3. Loop not as per prototype.
4. Inappropriate use of throttle.
5. Loop not finished at Low Flight Level.

**G Three Inverted Laps:**

The model aircraft should make three smooth and stable consecutive laps in an inverted position at Low Flight Level. Height should remain constant for optimum marks.

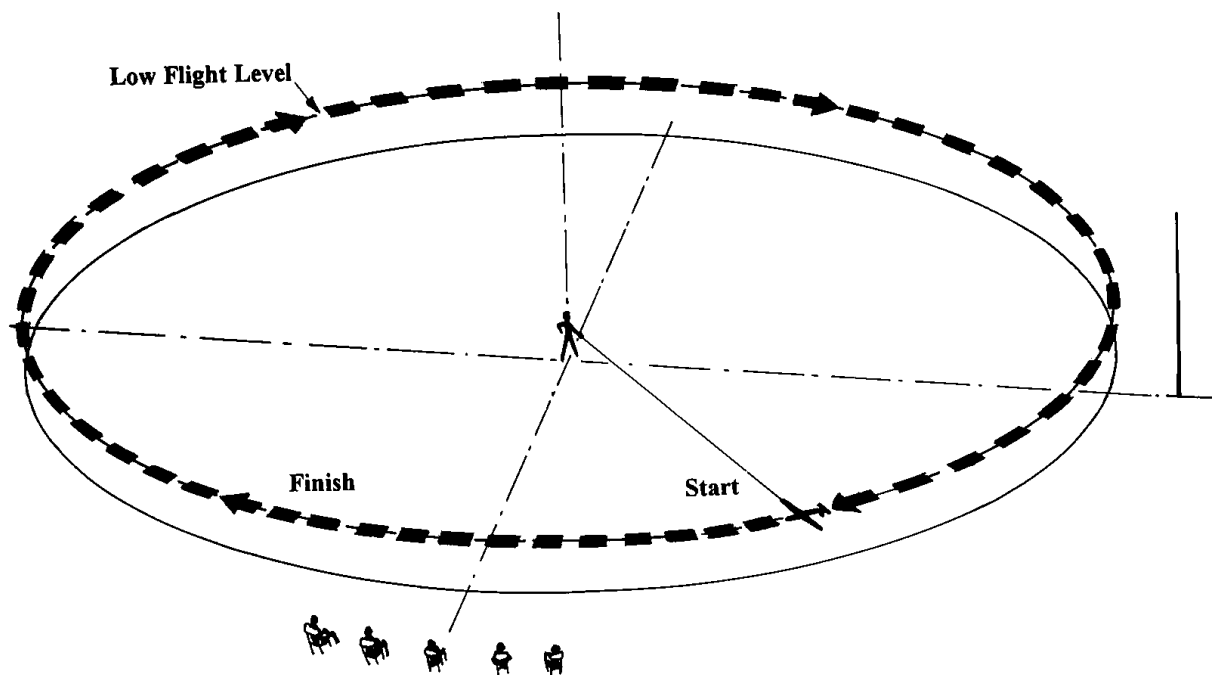

Errors:

1. Less than three laps, zero marks.
2. The height not at Low Flight Level.
3. Not smooth and stable.
4. Variations in height.

**H. Wingover:**

From Low Level Flight the model aircraft should make a near vertical climb, then perform an equally near vertical dive and finally level out at Low Level Flight. The radius in the pull-up and the pull-out should be of equal size for full marks. Low powered aircraft types would be expected to execute a shallow dive at full throttle in order to pick up speed before commencing the manoeuvre.

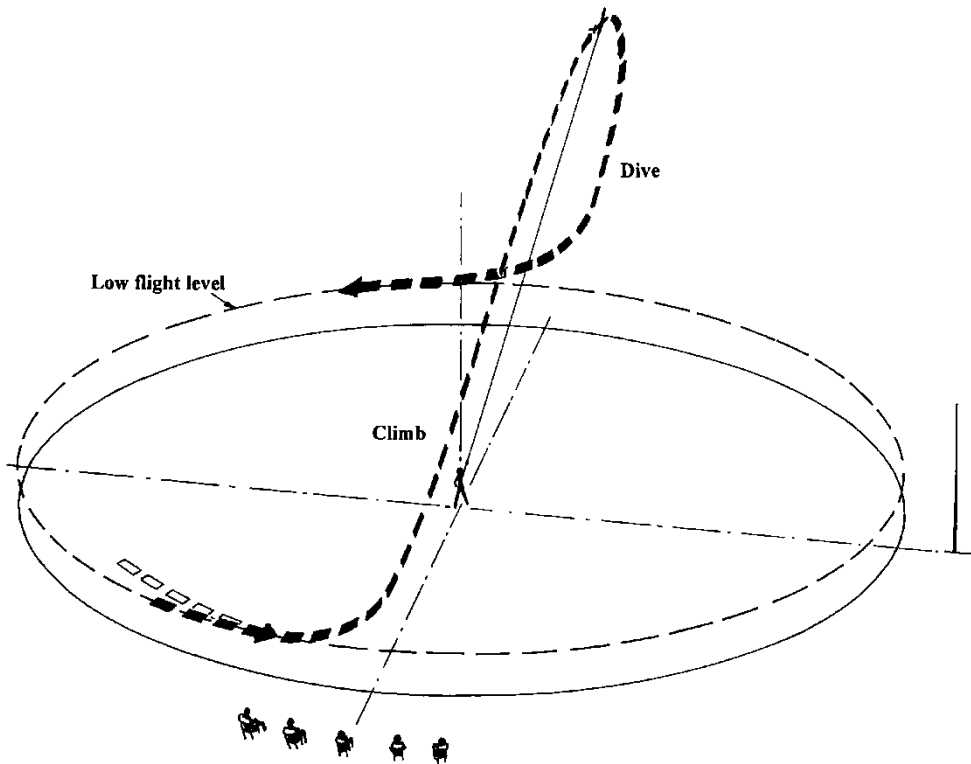
**Errors:**

1. Not commenced from Low Level Flight.
2. Not sufficiently steep climb. (Less than 60° will score zero).
3. Not sufficiently vertical dive. (Less than 60° will score zero).
4. Not equal shape in the pull-up and the pull-out.
5. The manoeuvre is not finished at Low Level Flight.

**I Figure Eight:**

From Low Level Flight, the model aircraft pulls up into a near circular loop until 45° nose down. The 45-degree inverted is then held until the entry height is reached when another near circular loop is executed inverted. The manoeuvre is completed with a second 45° nose down and a pullout at Low Level Flight. The 45-degree intersection shall divide the manoeuvre in two equal parts for top marks.

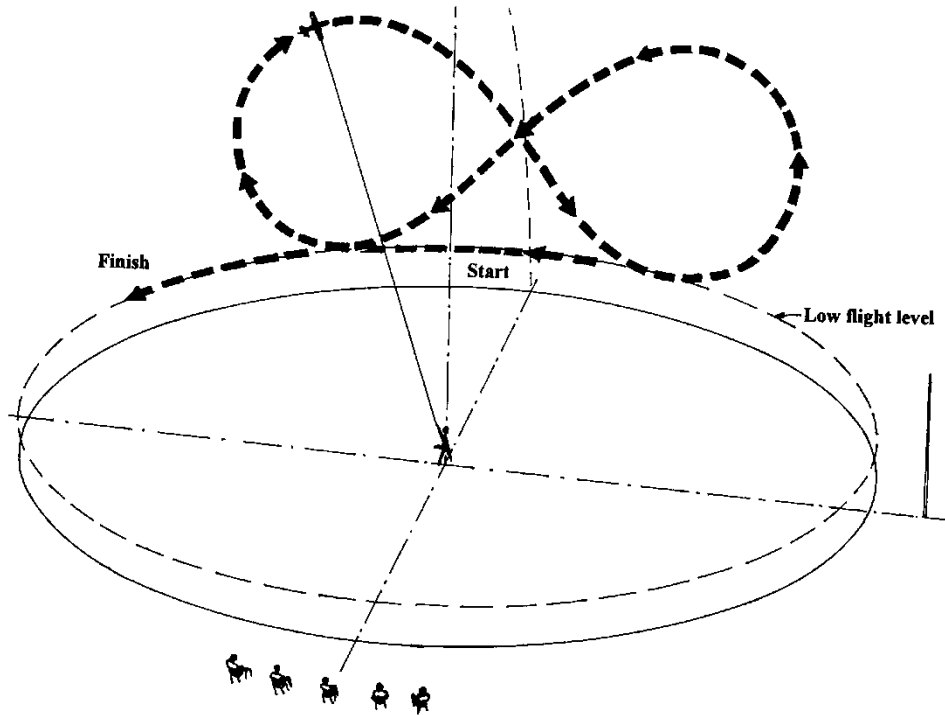
**Errors:**

1. Manoeuvre not commenced from Low Flight Level.
2. Loops not near circular.
3. Not a 45° intersection.
4. Loops are not the same size.
5. The manoeuvre not finished at Low Flight Level.

**J Touch and Go:**

From Normal Flight Level, the model aircraft reduces speed and extends landing gear and flaps, as applicable to the subject aircraft, touches down and rolls along the ground without coming to a halt. The main wheels must roll along the ground for a minimum of five metres of the actual model aircraft. The model aircraft then makes a normal take-off and completes the manoeuvre at Normal Flight Level. The descent, prior to touch down, may take more than one lap to complete.

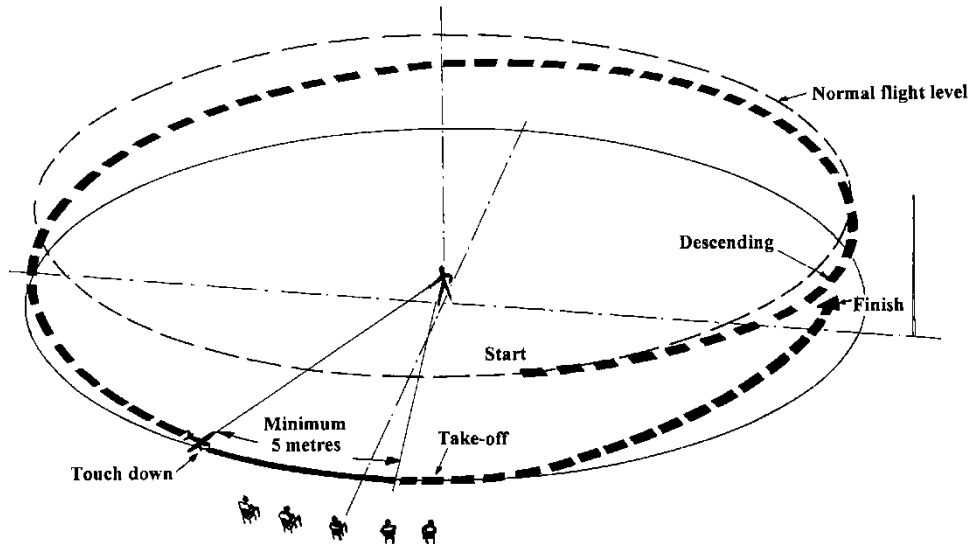
**Errors:**

1. Descent not commenced from Normal Flight Level.
2. Throttle, gear and flaps not operated smoothly during the descent.
3. The model aircraft bounces on touch down and the continuing roll on the ground.
4. The roll on the ground is less than five lengths of the model aircraft.
5. Not a normal take off and climb out to Normal Flight Level.



**K Lazy Eight**

From Low Flight Level in front of the judges the model aircraft describes a climbing turn to High Flight Level and down again opposite the judges. The climbing turn is then immediately repeated in the other half of the circle and finished in front of the judges at Low Flight Level. This manoeuvre is for all sorts of aircraft.

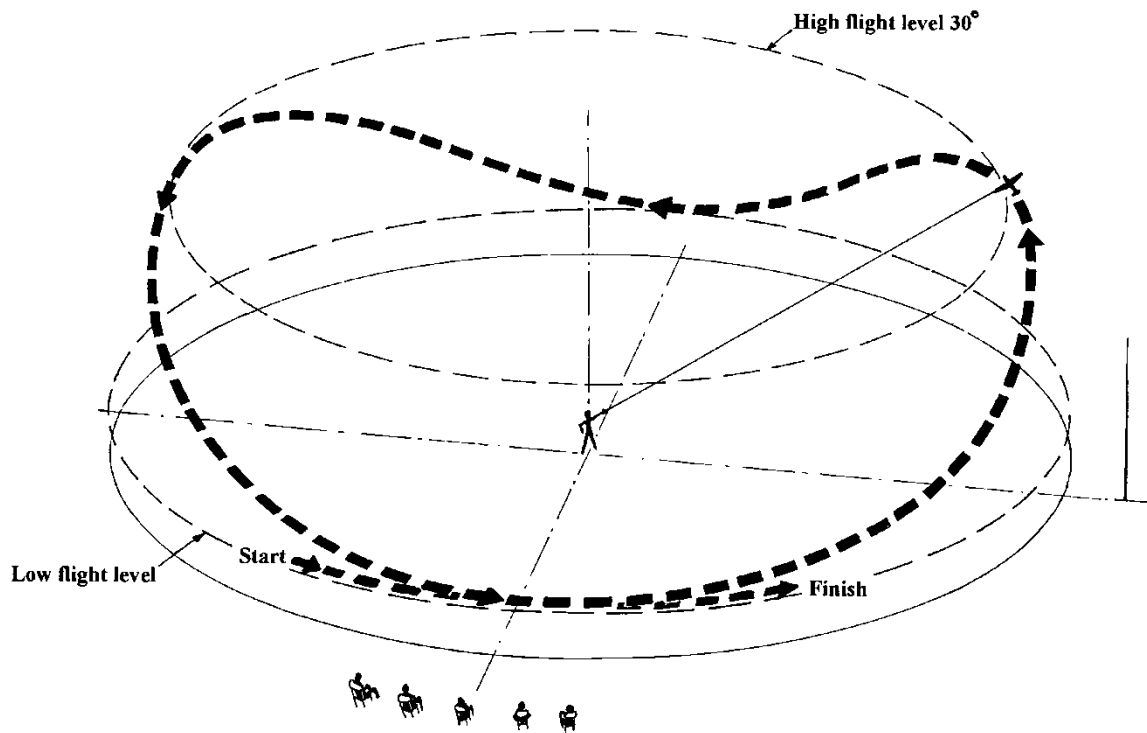
Errors:

1. The manoeuvre not executed from Low Level Flight
2. The climbing turn not to High Flight Level
3. The second climbing turn not a copy of the first
4. The manoeuvre not finished at Low Flight Level
5. The manoeuvre not centred in front of the judges

**L Parachute drop:**

The drop or ejection should be in the manner of the subject aircraft. Cargo should be dropped from a hatch or from bomb bays. A man should be dropped via doors, a hatch or by inverting the aircraft. If the subject aircraft used a braking parachute when landing, the competitor may demonstrate this aspect for this manoeuvre. The dropping zone shall be positioned in front of the judges as a circle with the radius of five (5) meters and shall be clearly marked on the ground with paint or tape.

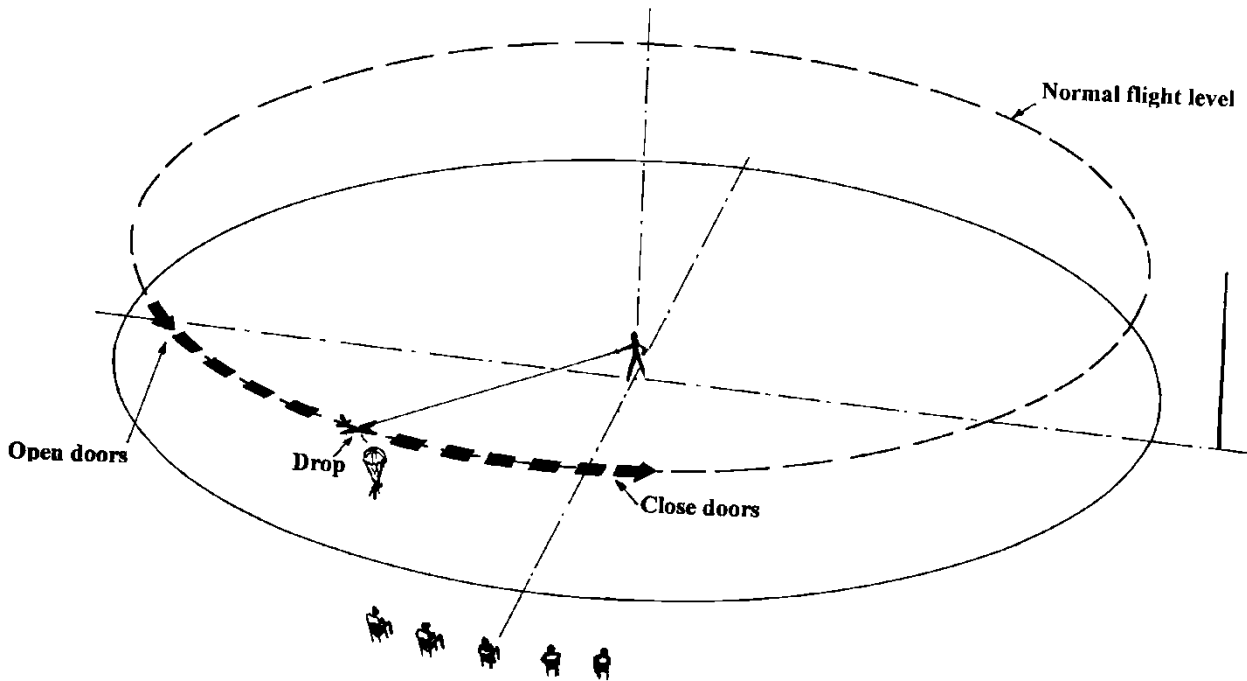
**Errors:**

1. Not a realistic way of dropping or ejecting the parachute.
2. The parachute not dropped at the agreed spot or area.

**M Flight Function by the subject aircraft:**

The competitor may demonstrate **one** flight function of his own choice, in each flying round. These must be agreed prior to the commencement of the flight program.

Note: Not more than one drop option may be nominated.

Flight functions should be of a nature that is easily understood by the judges. Pure mechanical options, which could equally be performed on the ground, are not allowed.

**N Overshoot:**

From Normal Flight Level, the model aircraft reduces speed and extends landing gear and flaps, as applicable to the subject aircraft. When the model aircraft reaches not more than one metre height and at least 15 meter length it picks up speed before it then makes a normal climb out and completes the manoeuvre at Normal Flight Level. The descending to approximately one metre may take more than one lap to finish.

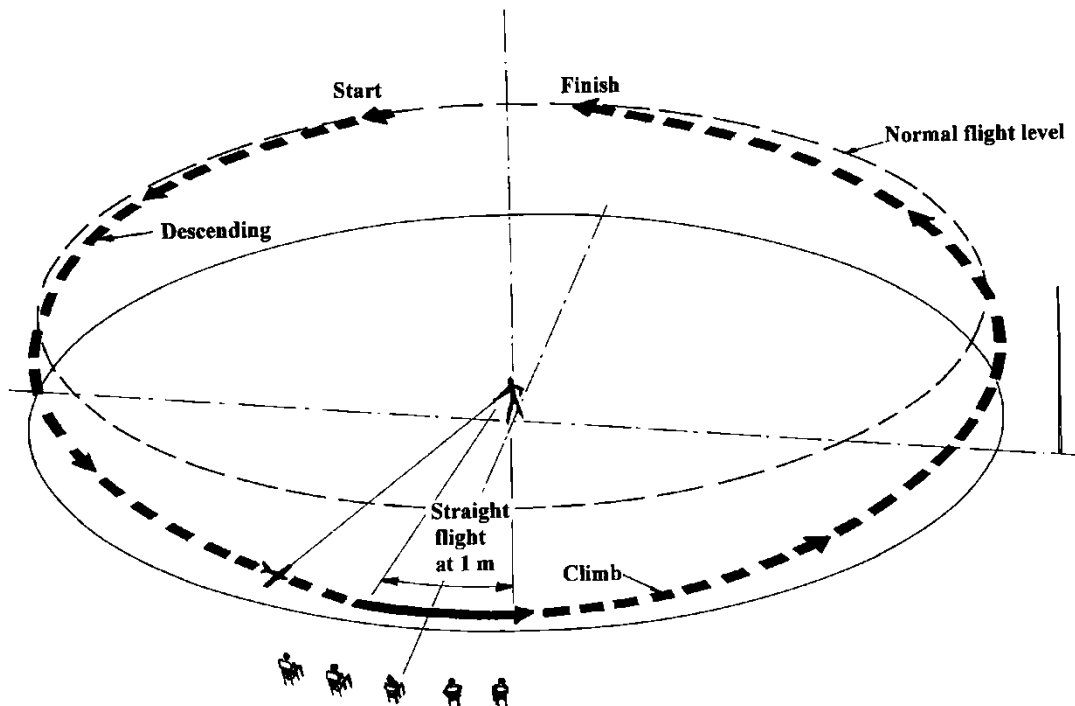

Errors:

1. Descent not commenced from Normal Flight Level
2. Throttle, gear and flaps not operated smoothly during descent.
3. The model aircraft not allowed to accelerate smoothly before climbing out.
4. The manoeuvre not finished at Normal Flight Level.

**6B.2.6.7. Landing and Taxi:**

From Normal Flight Level, the model aircraft smoothly descends while throttling back and begins the approach with flaps and gear down, when applicable, the model aircraft then continues to round out, adopting the attitude applicable to the subject aircraft and touches down with no bouncing and rolls to a stop. The landing may take more than one lap to finish. The model aircraft should then taxi a minimum distance of 15 metres in a realistic manner and speed and finally come to a full stop. All engines must be operating for full marks.

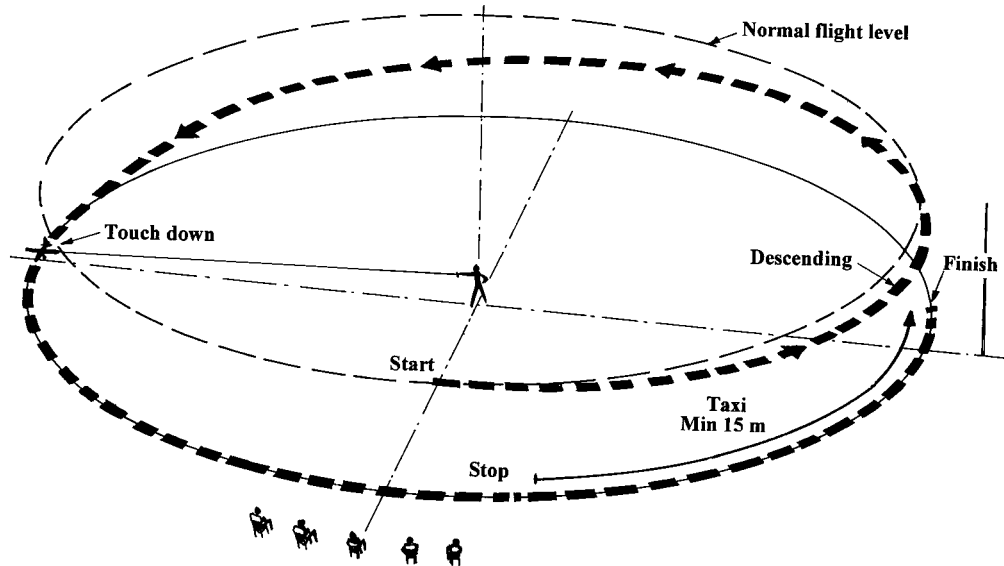
**Errors:**

1. Landing manoeuvre not commenced from Normal Flight Level.
2. Not a smooth descent down to the touchdown point.
3. Gear/flaps not lowered in correct positions.
4. Excessive use of throttle on finals.
5. Model aircraft too fast, not correct approach configuration.
6. Model aircraft bounces on touch down.
7. Model aircraft does not come to a gradual and smooth stop after landing.
8. Model aircraft noses over (30 % penalty when nose-down, zero if it overturns).
9. Engine(s) stops before the landing manoeuvre is finished.
10. Taxi not 15 metres.
11. Not a realistic taxi for the subject aircraft.

### 6B.2.6.8. Realism of Flight:

All judges should discuss this after completion of the flight and they should attempt to arrive at an agreed score for each item. Realism of Flight covers the entire flight performance including the way the model aircraft flies between the manoeuvres. Judges will allot points for Realism within the following aspects, always keeping in mind the likely characteristics of the subject aircraft.

Engine sound (Tone and Tuning) ..... K = 4

"Tone" relates to the character of the sound by comparison with the subject aircraft at all throttle settings.

"Tuning" is the smoothness of operation of the engine at all throttle settings.

The marks for engine sound should therefore be split equally between these two aspects.

Speed of the model aircraft ..... K = 6

This should be an assessment of the scale speed of the model aircraft, calculated from the speed of the full size aircraft (as indicated on the score sheet and documentation) divided by the scale of the model aircraft. Model aircraft invariably fly faster than scale speed and marks should be deducted accordingly. For example, a model aircraft that appears to be flying at twice scale speed should score no more than half marks, a model aircraft flying at three times scale speed, or faster, should score zero.

Smoothness of flight ..... K = 6

The model aircraft should be well trimmed and show no signs of instability. Judges should assess the smoothness of control taking into account the prevailing weather conditions.

They should also judge the attitude of the model aircraft in flight, i.e. any nose-up or nose-down tendency.

Notes: A model aircraft, which flies with wheels down, whereas the subject aircraft actually featured retractable landing gear, shall have the total flight score reduced by 25%.

If the pilot of the subject aircraft is visible from the front or from the side during flight, a dummy pilot of scale size and shape shall be equally visible during flight in the model aircraft. If such a pilot is not fitted, the total flight score shall be reduced by 10%.

**PAGE DELIBERATELY LEFT BLANK**

## ANNEX 6C

### CLASS F4C JUDGES' GUIDE - FLYING SCHEDULE

#### 6C.1 General

All flying manoeuvres must be judged bearing in mind the performance of the full size prototype. The aim of the scale flight schedule is to recreate the flight characteristics and realism of the full-size aircraft. Judges must not therefore confuse scale contests with aerobatics contests

The errors mentioned under each manoeuvre cannot be an exhaustive list of all possible faults. They are intended to show the sort of mistakes that are likely during that manoeuvre. These errors examine each manoeuvre from three aspects:

1. The shape, size and technical requirements of the intended manoeuvre.
2. The positioning of the manoeuvre relative to the judges position or other datum.
3. The scale realism achieved relative to the subject aircraft.

It remains the responsibility of the judges to decide upon the importance of each error and deduct marks accordingly, always taking into account the characteristics of the full size aircraft.

Each manoeuvre must be announced prior to commencement and called on commencement by the word "NOW". All flying manoeuvres must be announced upon completion by the word "FINISHED".

The flying judges will be seated alongside the landing area in a line parallel with the wind direction. This axis will be referred to as the "judges' line". The Contest/Flight Line Director will be responsible for the measuring of wind direction. If, in the opinion of the Contest/Flight Line Director, the wind direction continually deviates more than 30° from the judges' line, the judges' line will be adjusted accordingly.

Unless there is a conflict with safety, the pilot should at all times be permitted to choose the direction of take-off and landing to allow for unexpected changes in wind direction. This provision will also apply to manoeuvre 6.3.7.M (Touch-and-Go) since this consists of both a landing and take-off.

Apart from the manoeuvres mentioned above, all manoeuvres must be performed parallel with the judges' line such that if any part of the manoeuvre is performed behind the judges' line it will score ZERO.

In the interests of safety, any manoeuvres overflying a designated area behind the judges' line laid out for the protection of spectators, officials and other competitors or helpers, will score ZERO.

The height and positioning of individual manoeuvres should be proportional to that expected in a full size display typical to each prototype. Unless specified otherwise, manoeuvres that are carried out in a horizontal plane (eg Straight Flight, Figure Eight, Triangular Circuit) should commence on a flight path that is about 60° elevation to the judges. Manoeuvres such as the Descending Circle and Spin should start at a higher elevation. Judges should down mark manoeuvres as too high, too low, too far away, or too close if they consider the positioning to be so.

After each flight, the Flight Judges will record any non-standard event that causes downgrading or loss of flight points. If for any reason the mark awarded is corrected or changed, the change must be initialled by the judge. The Chief Flight Judge will review all flight score sheets for completeness and fairness and justification of any zero scores. As examples: missed manoeuvres, manoeuvres flown out of order, out of flight time, flying behind the "Judges' Line", or crash landing. The Chief Flight Judge must then sign the score sheets before they are sent for processing.

*cont/...*

**6C.3.6.1. Take-Off:**

The model aircraft should stand still on the ground with the engine running without being held by the pilot or mechanic and then take-off into wind, or as required by the competitor to make best use of the take-off distance available (jet subjects). If the model aircraft is touched after the competitor calls "Now" the take-off will score zero. The take-off should be straight and the model aircraft should smoothly accelerate to a realistic speed, and then lift gently from the ground and climb at an angle consistent with that of the prototype. The take-off is completed after the model aircraft has turned 90 degrees.

If the prototype used flaps for take-off, then the model aircraft should also, but this may be subject to the competitor's judgement taking into account the wind strength. Any flapless take-off due to wind must be nominated to the judges before take-off. Flaps should be raised during the climb-out after take-off. If applicable, the landing gear should be retracted during the climb-out.

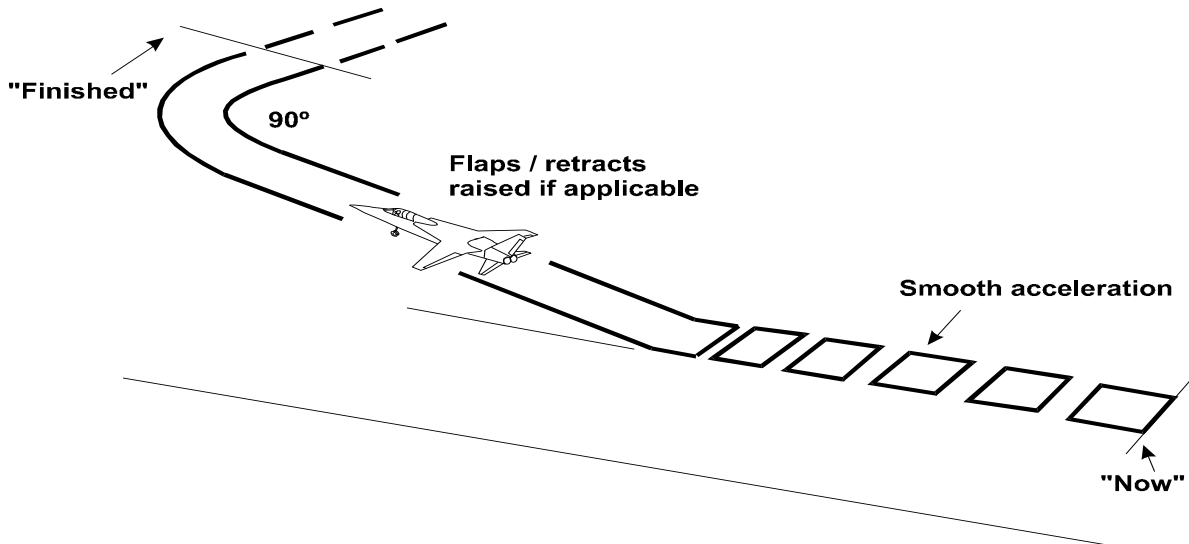
**Errors:**

1. Model aircraft touched after calling "Now" (zero marks).
2. Swings on Take-off (a slight swing with other than a tricycle undercarriage is acceptable as the aircraft tail is raised).
3. Take-off run too long or too short.
4. Unrealistic speed /too rapid acceleration.
5. Inappropriate attitude at lift-off for undercarriage configuration.
6. Not a smooth lift-off.
7. Climb rate wrong (too steep or too shallow).
8. Nose attitude wrong during climb (nose too high or too low).
9. Flaps not used if applicable.
10. Wheels not raised if applicable.
11. Significant wing drop.
12. Climb-out track not same as take-off run.
13. Unrealistic rate of turn onto crosswind leg.
14. Crosswind track not 90° to climb out track.



**6C.3.6.2. Figure Eight**

The model aircraft approaches in straight and level flight on a line parallel with the judges' line, and then a one-quarter circle turn is made in a direction away from the judges' line. This is followed by a 360-degree turn in the opposite direction, followed by a 270-degree turn in the first direction, completing the manoeuvre on the original approach line.

The intersection (mid point) of the manoeuvre shall be on a line that is at right angles to the direction of entry and passes through the centre of the judges' line.

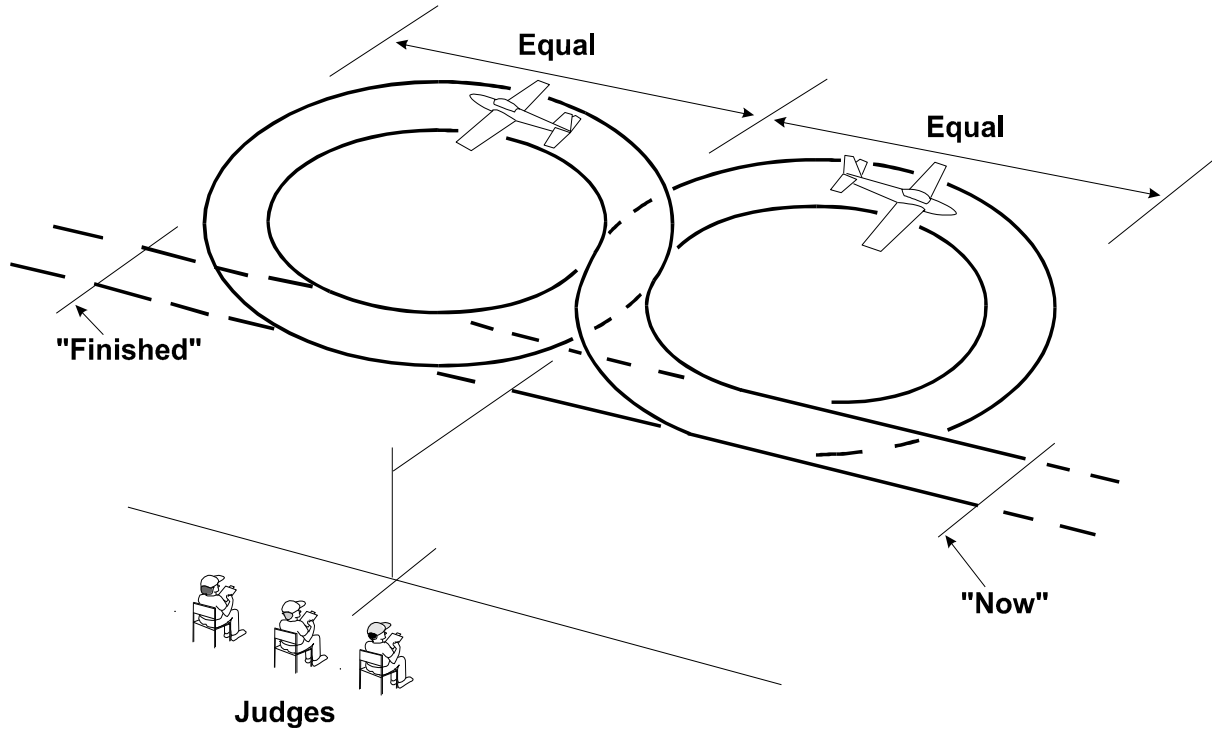
**Errors:**

1. Entry into first circle not at right angles to original flight path.
2. Circles unequal size.
3. Circles misshapen
4. Constant height not maintained.
5. Intersection not centred on judges' position.
6. Entry and exit paths not on same line.
7. Entry and exit paths not parallel with judges' line.
8. Overall size of manoeuvre not realistic for prototype.
9. Model aircraft flight path not smooth and steady.
10. Too far away/too close/too high/too low.

**6C.3.6.3. 3600 Descending Circle at Constant Low Throttle Setting:**

Commencing from straight and level flight, the model aircraft performs a gentle 360° descending circle over the landing area, in a direction away from the judges, at a constant low throttle setting. The manoeuvre terminates at a maximum height of 6 metres, resuming straight and level flight on the same path.

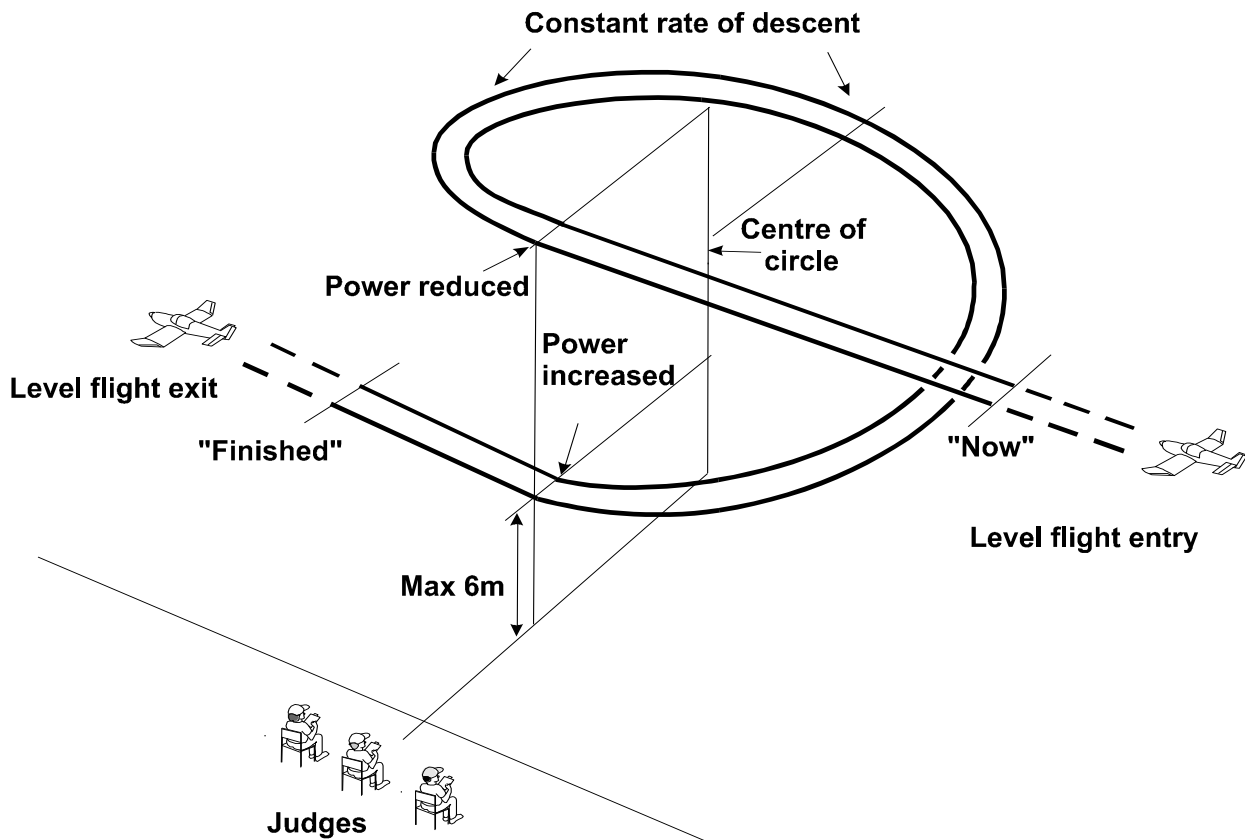

Errors:

1. Rate of descent not constant.
2. Descent too steep.
3. Throttle setting not constant or low enough.
4. Circle misshapen.
5. No significant loss of height.
6. Model aircraft does not descend to 6 metres or below.
7. Circle not centred on judges' position.
8. Entry and exit paths not parallel with the judges' line.
9. Start and finish not called in straight and level flight.
10. Too far away, too close.

**6C.3.6.4. Optional manoeuvre, see 6C.3.7**

**6C.3.6.5. Optional manoeuvre, see 6C.3.7**

**6C.3.6.6. Optional manoeuvre, see 6C.3.7**

**6C.3.6.7. Optional manoeuvre, see 6C.3.7**

**6C.3.6.8. Optional manoeuvre, see 6C.3.7**

**6C.3.6.9. Optional manoeuvre, see 6C.3.7**

**6C.3.6.10 Approach and Landing**

The manoeuvre commences by descending from base leg (in the same way as the Touch and Go). Prior to this point the model aircraft may complete any form of appropriate circuit to achieve a landing configuration. This may be a full rectangular or oval pattern, or a join directly onto the downwind or base legs. The Approach and Landing may be orientated into wind, or as required by the competitor to make best use of the landing distance available ( eg jet subjects).

The base leg may be either straight or curved as required by the pilot. From the start position the model aircraft completes the turn through 90 degrees onto final approach. The model aircraft should round out smoothly, adopting the attitude applicable to the specific type and touch down without bouncing before smoothly rolling to a stop. An aircraft with conventional landing gear will make a three-point landing or will land on the main wheels and then gently lower the tail, as appropriate to the prototype, the prevailing wind conditions, or the surface of the landing area. An aircraft with tricycle landing gear will land on the main wheels first and then gently lower the nose wheel.

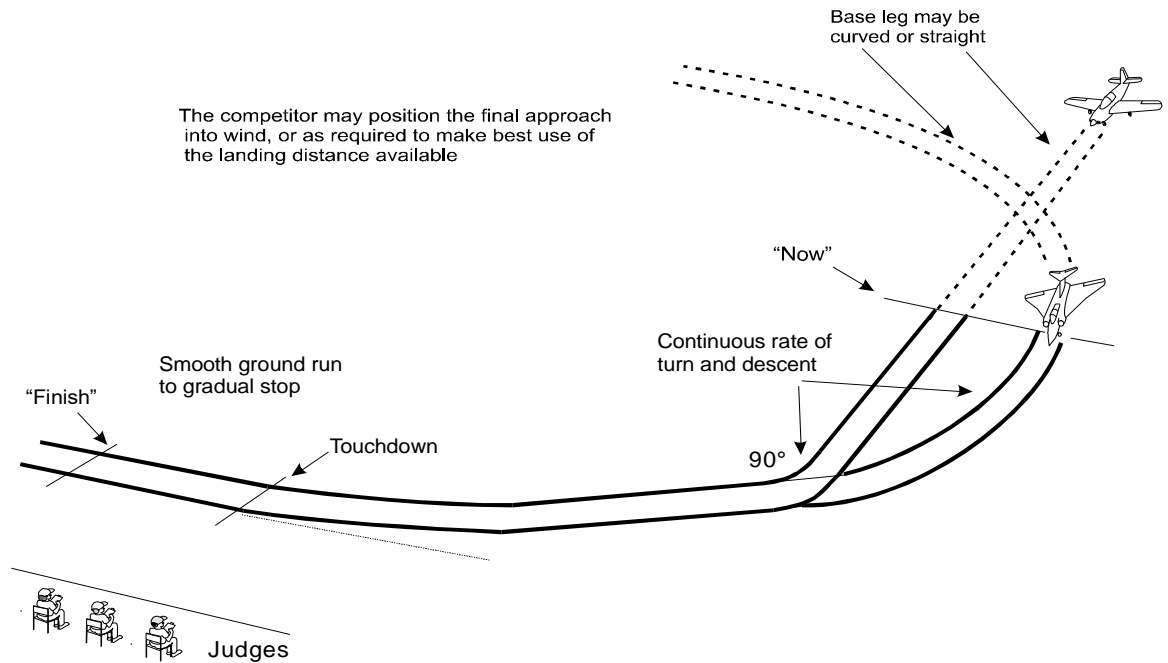

**Errors:**

1. Manoeuvre does not commence on base leg.
2. Turn onto final approach not constant rate or not 90°.
3. Descent from base leg not smooth and continuous.
4. Model aircraft does not achieve correct landing approach prior to touchdown.
5. Model aircraft does not round out smoothly.
6. Model aircraft bounces.
7. Drops a wing during landing.
8. Touches wing tip on ground.
9. Does not come to a gradual and smooth stop after landing.
10. Does not adopt landing attitude appropriate to subject type.
11. Model aircraft runs erratically or turns after landing.
12. Model aircraft noses over (note 2 points penalty if only nose-down; zero if it over-turns).

cont/...

Note: A crash landing scores zero points, but if the model aircraft makes a good landing and then stops nose down towards the end of the landing run, the landing marks that would have been otherwise awarded should be reduced by 2 points.

If the nose down situation is solely the result of the model aircraft running off the prepared area, because this is too short for the particular wind direction, the above down marking will not apply.

Model aircraft with retractable landing gears, landing with one or more gears retracted should have the landing points reduced by 30%.

All landings ending with the model aircraft on its back will be considered a crash landing.

**6C.3.6.11.Realism in Flight**

Realism in Flight covers the entire flight performance including the way in which the model aircraft flies between manoeuvres.

Judges will allot points for Realism within the following aspects, always keeping in mind the likely characteristics of the full size subject:

Flight Presentation..... K = 4

Most aircraft are somewhat aerobatic, while some are totally non-aerobatic and others are purpose designed for aerobatics. It is up to the competitor to select manoeuvres that would typically be flown by the prototype in an air show style performance. Any documentation to verify the selection of manoeuvres shall be attached to the Competitors Declaration form, of which a copy will be made available to the Chief Flight Judge by the organisers after Registration of Teams has been completed.

Aspects of the flight to be considered are:

1. The variety and combination of manoeuvres, including the turn-around manoeuvres into the presentation in order to give a flowing display.
2. Ideally, the turn-around manoeuvres should result in the model aircraft being properly positioned at the right altitude and track for the next manoeuvre in the sequence in order to minimise 'dead' fly pasts to get the model to the other side of the flight line.
- 3, The inclusion of more complicated and/or risky manoeuvres such as full Cuban Eights, Slow Rolls, Point Rolls, Snap Rolls, Overhead Triangles and Rectangles and Touch and Goes should be rewarded more, compared with sequences consisting of simple single element manoeuvres.
4. Power Management by the pilot. The management of the power settings of the model during the various flight phases is of importance as well as the transition between settings. The sound of the power plant is to be judged more as a generic sound relating to the type of power plant and aircraft, rather than whether it is representing a specific power plant.

Speed of the model aircraft..... K = 9

This should be a subjective assessment of the scale speed of the model aircraft, based on the speed of the full size aircraft (as indicated on the score sheet and documentation) judged as if it were performing a public flying display. Model aircraft invariably fly faster than scale speed and marks should be deducted accordingly. For example, a model aircraft that appears to be flying at twice scale speed should score no more than half marks, a model aircraft flying at three times scale speed, or faster, should score zero.

Smoothness of flight ..... K = 9

The model aircraft should be well trimmed and show no signs of instability. Judges should assess the smoothness of control taking into account the prevailing weather conditions. They should also judge the attitude of the model aircraft in flight, i.e. any nose-up or nose-down tendency.

Realism in flight aspects shall be discussed by all flight judges after completion of the flight in consultation with any claim for non-aerobatic eligibility made on the Competitor's Declaration form (Annex 6C.1). The judges should attempt to arrive at an agreed score for this item.

Some original prototypes would have little or no aerobatic capability. These are aircraft designed with limited manoeuvrability where the original prototypes of which were restricted by the manufacturer or licensing government agency. Examples are touring aircraft, passenger and cargo aircraft and heavy military transports and bombers. The optional manoeuvres are included under 6.3.7. to cater for such subjects. These aircraft should still be considered for high marks in this section if the performance of the original prototype genuinely limits them to such manoeuvres. Conversely, if aircraft with greater manoeuvrability and performance choose these options when the original prototype would be capable of much more, then low marks should be awarded in this section.

**NOTES:**

1. For any model aircraft that flies a manoeuvre with two or more wheels down, where the prototype actually featured retractable landing gear, the score shall be reduced by two points on that manoeuvre. If one wheel is down, the score shall be reduced by one point. If one or more wheels are only sagging during the manoeuvre, the score shall be reduced with one half or one point depending on the seriousness of the sagging.
2. If the pilot of the prototype is visible from the front or from the side during flight, a dummy pilot of scale size and shape shall be equally visible during flight in the model aircraft. If such a pilot is not fitted, the total flight score shall be reduced by 10%.

*cont/...*

**6C.3.7. Optional Manoeuvres**

The selection of optional manoeuvres should demonstrate the fullest possible capabilities of the aircraft subject type modelled.

The selection of manoeuvres and the order in which they are to be flown must be shown on the score sheet and given to the judges before each flight. This order must be adhered to and any manoeuvre flown out of sequence will score ZERO.

**A. Chandelle:**

From a straight and level flight the model aircraft passes the judges and then performs a 180° climbing turn in a direction away from the judges, resuming straight and level flight on the opposite heading. The rate of climb should be commensurate with that of the prototype.

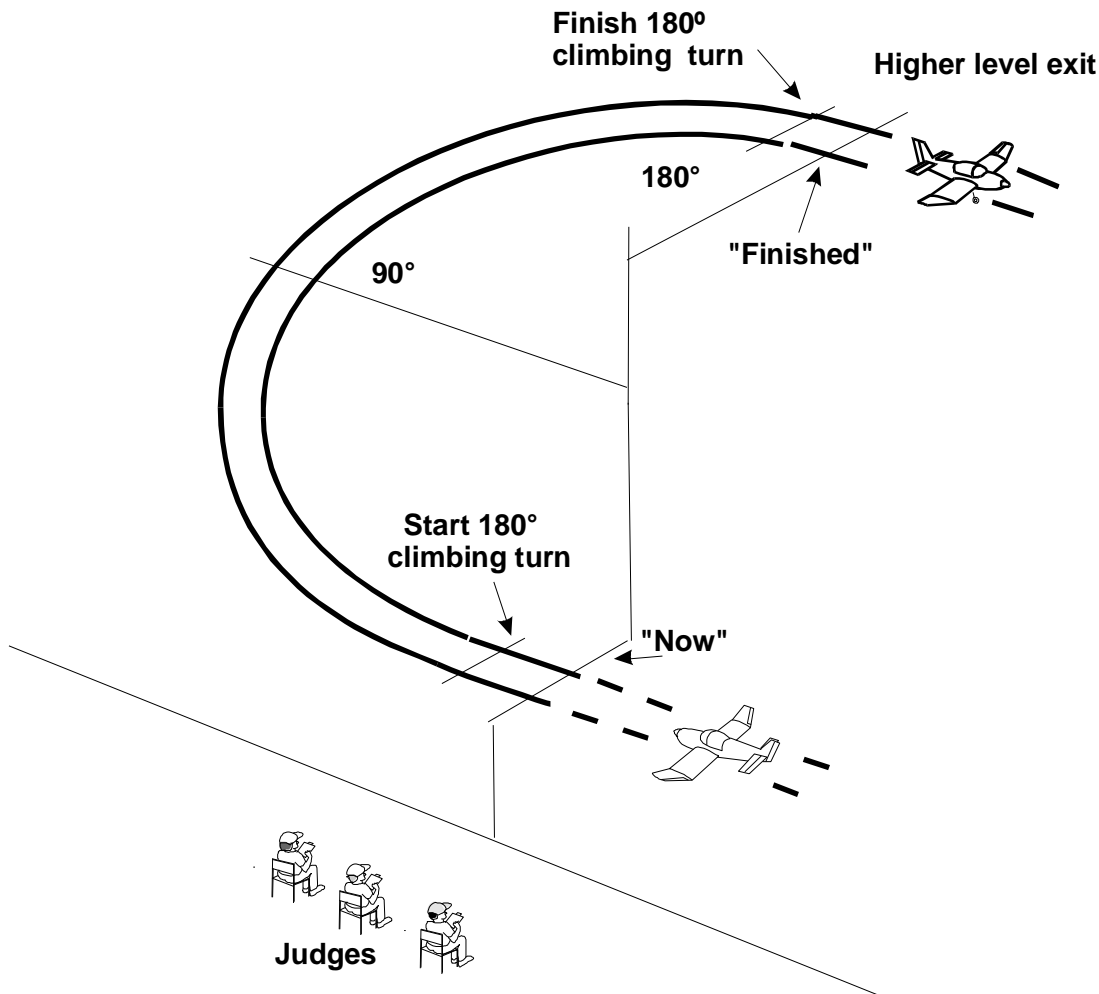
**Errors:**

1. Turn not smooth and continuous.
2. Climb not smooth and continuous.
3. Half height gain not at 90° position.
4. Excessive/unrealistic engine power used to achieve the climb.
5. Insignificant height gain.
6. Start and finish not centred on judges' position.
7. Entry and exit paths not parallel with the judges' line.
8. Final track not 180 degrees opposite to entry.
9. Entry and exit not in straight and level flight.
10. Too far away or too high.

**B. Extend and Retract Landing Gear:**

**C. Extend and Retract Flaps:** (Diagram and errors applicable to both manoeuvres unless stated)

Model aircraft approaches the landing area in straight and level flight at a height not exceeding 15 metres and in full view of the judges, extends the landing gear/flaps. Model aircraft then executes a 360° turn in a direction away from the judges, and when again directly in front of the judges retracts the landing gear/flaps and climbs away in straight flight.

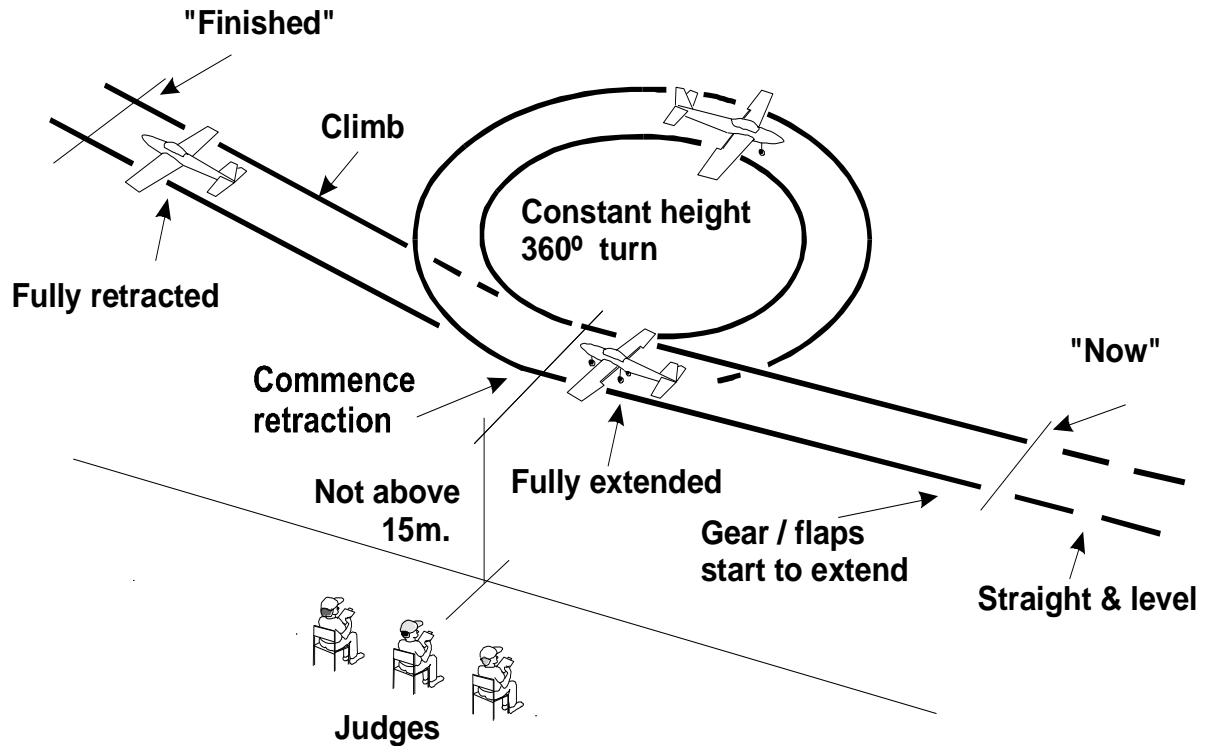

Errors:

1. Model aircraft speed too high for landing gear/flap lowering.
2. Gear/flaps not extended in full view of judges.
3. Speed and sequence of extension and retraction not realistic.
4. Flaps demo only:
  - a) Instability when flaps lowered,
  - b) No change in attitude with flaps.
5. Misshapen circle or not constant height.
6. Circle height exceeds 15 metres.
7. Circle not centred on judges' position.
8. Retraction not commenced abeam judges.
9. Entry and exit paths not parallel with the judges' line.
10. Entry and exit tracks not the same.
11. Un-scale-like climb out.
12. Too far away or too close.

**D. Dropping of Bombs or Fuel Tanks:**

If bombs are carried internally, bomb-bay doors must be open and be closed after the drop.

If bombs or fuel tanks are carried externally, they must be fitted in the correct positions and in the correct manner. Dropping should be in the manner of the prototype.

Dropping should be within clear view of the judges and centred on the judges' position.

Any special features of the manoeuvre should be declared to the judges beforehand.

Errors:

1. Bombs or tanks do not detach and fall in a realistic manner.
2. Drop is not in front of judges.
3. Overall dropping manoeuvre not presented in a realistic way.
4. Too far away/too close/too high/too low.

*cont/...*



**E. Stall Turn:**

The model aircraft starts in level flight, noses up to a vertical flight path until it comes to a stop. At which point the model aircraft yaws through 180 degrees, then dives and finally recovers straight and level on a flight path in the opposite direction to the entry. Entry and exit should be at the same height. The competitor should specify whether the turn shall be to the left or right. Low powered aircraft types would be expected to execute a shallow dive at full throttle in order to pick up the necessary speed before commencing the manoeuvre.

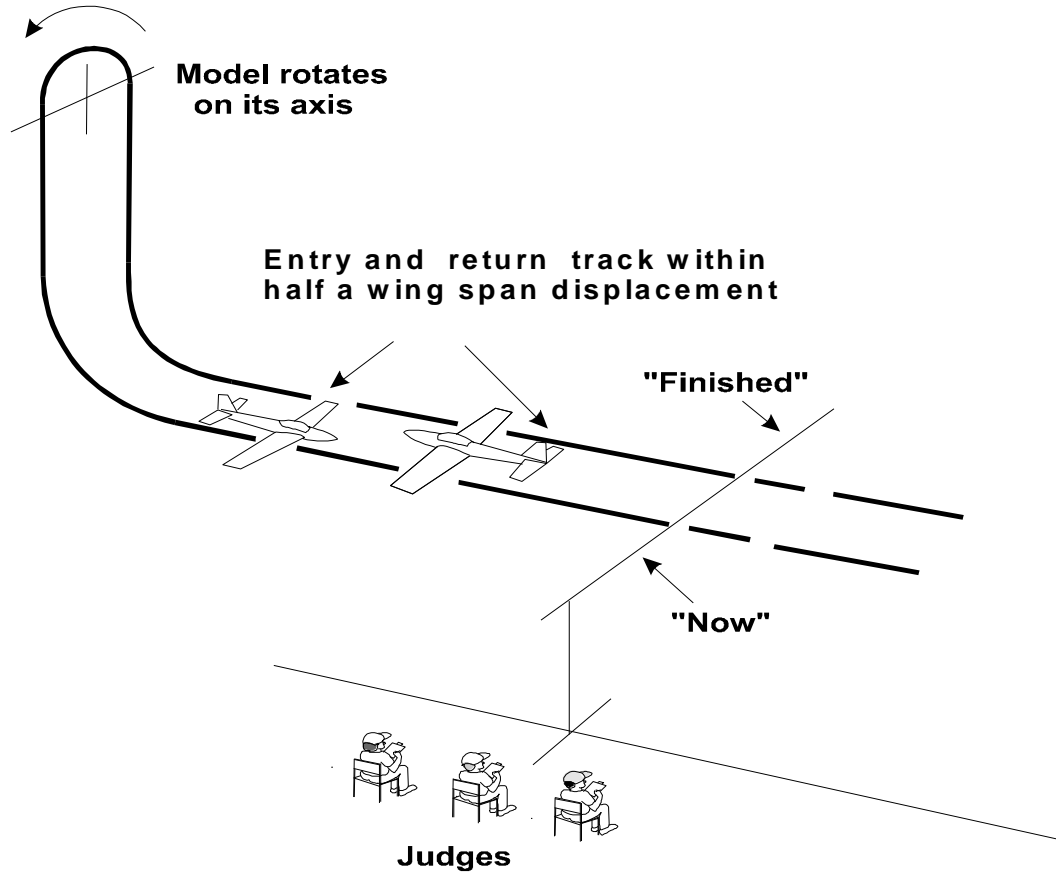
**Errors:**

1. Start and finish not parallel with judges' line.
2. Pull up not positioned to give best view to judges.
3. Climb and descent not near vertical.
4. Insufficient height gain.
5. Model aircraft does not stop.
6. Competitor does not specify or achieve nominated left/right turn.
7. Entry and exit paths are not at same height.
8. Model aircraft does not exit within half span displacement of entry track.
9. Entry and exit paths not parallel with the judges' line.
10. Too far away/too close/too high/too low.

**F. Immelmann Turn:**

From a straight and level flight the model aircraft pulls up into the first half of a circular loop (commensurate with the performance of the subject type), and when inverted, performs a half roll before resuming straight and level flight on the opposite track. Low powered aircraft types would be expected to commence the manoeuvre by executing a shallow dive at full throttle in order to pick up the necessary speed.

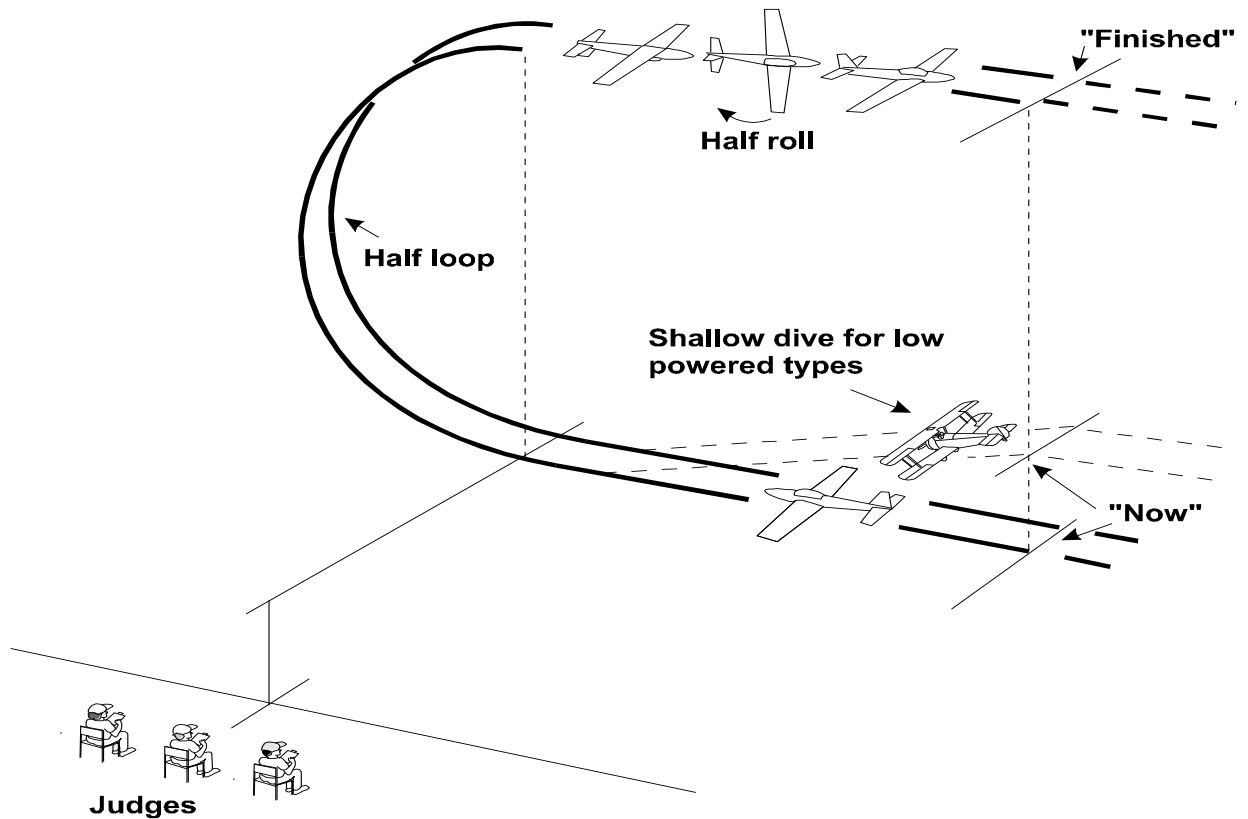
**Errors:**

1. Track of the half loop not vertical.
2. Half loop not centred on judges' position.
3. Half loop is not sufficiently semicircular.
4. Roll starts too early or too late.
5. Excessive height loss in the roll.
6. Track veers during the roll.
7. Does not resume straight and level flight on the opposite track to entry.
8. Manoeuvre not flown parallel with judges' line.
9. Size of manoeuvre and speed not in manner of the prototype.
10. Too far away/too close/too high/too low.

**G. Loop:**

From straight flight, the model aircraft pulls up into a circular loop and resumes straight and level flight on the same heading as the entry. The throttle may be reduced at the top of the loop as appropriate to type, and opened if necessary when normal flight is resumed. Low powered aircraft types would be expected to execute a shallow dive at full throttle in order to pick up speed before commencing the loop.

Note: Whilst the loop is intended to be a circular manoeuvre, the ability of a low powered aircraft to achieve a perfect circle will be significantly less than that of a jet or high powered aerobatics machine. A slightly elongated loop by the former would therefore expect to score as well as a perfect circle achieved by the latter, but a grossly misshapen circle would be significantly down marked. This also applies to other options involving looping manoeuvres.

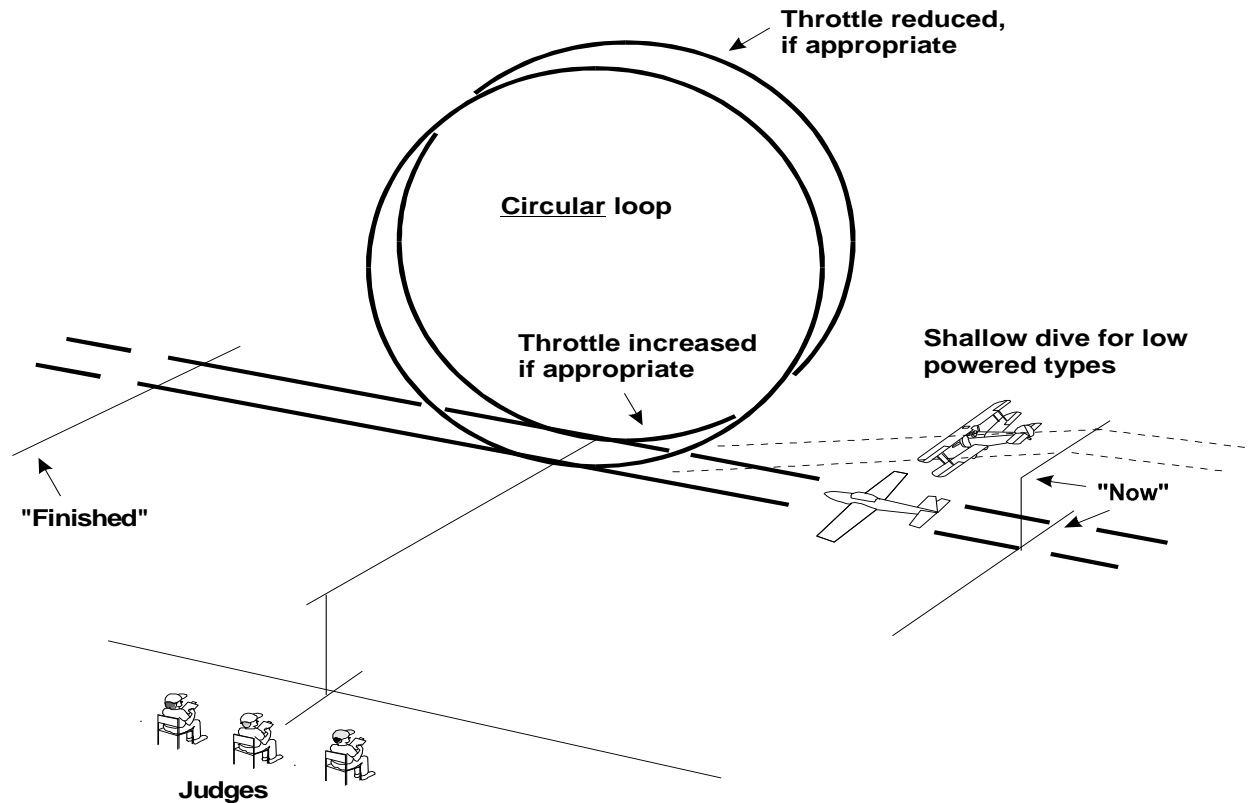
**Errors:**

1. Track of loop not vertical
2. Loop not sufficiently circular, commensurate with the subject type.
3. Inappropriate use of throttle.
4. Size and speed of Loop not in manner of prototype.
5. Not centred on judges' position.
6. Does not resume straight and level flight on same track and height as entry.
7. Manoeuvre not flown parallel with judges' line.
8. Too far away/too close/too high/too low.

## H. Cuban Eight:

The model approaches in straight and level flight on a track parallel to the judges line. After passing the judges centre line the model aircraft pulls up into a 5/8 inside loop to reach a 45° nose down attitude and then performs a half roll on the judges centre line. The 45° down line is held until a 3/4 inside loop is flown to repeat the manoeuvre in the opposite direction for a straight and level recovery at the same height and track as the original entry. The throttle may be closed at the top of each loop, as appropriate to the subject type, and reopened during each descent. A low powered aircraft would be expected to execute a shallow dive at full throttle in order to pick up speed before commencing the manoeuvre.

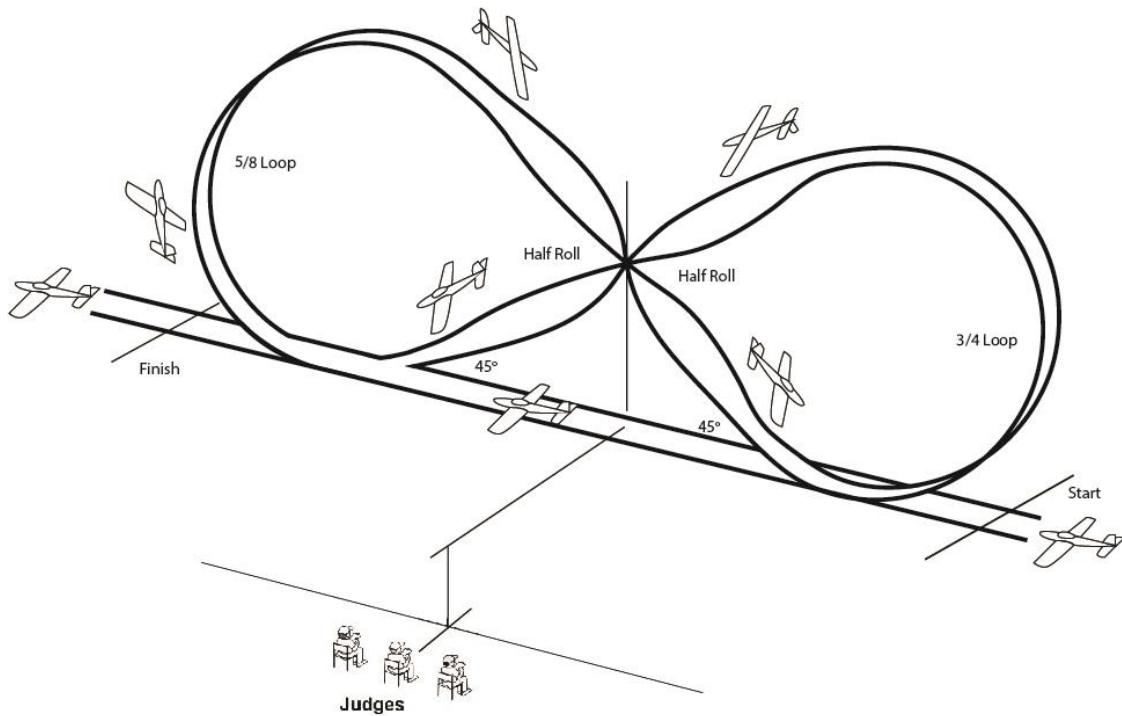

### Errors:

1. Manoeuvre not performed in a constant vertical plane that is parallel with the judges' line.
2. Loops are not circular.
3. Loops are not the same size.
4. Half rolls are not centred on the judges' position.
5. 45° descent paths not achieved.
6. Model aircraft does not exit manoeuvre at same height as entry.
7. Model aircraft does not resume straight and level flight on same track as entry.
8. Inappropriate use of throttle.
9. Size and speed of manoeuvre not in manner of prototype.
10. Too far away/too close/too high/too low.

## I. Reverse Cuban Eight:

The model approaches in straight and level flight, parallel to the runway and pulls through a 1/8 loop to a 45 degree up line before reaching the judges centre line and then performs a half roll in front of the judges. It then pulls through a 3/4 inside loop into a 45 degree up line and performs a half roll in front of the judges and then pulls through a 5/8 inside loop to resume straight and level flight to exit the manoeuvre at the same altitude and track as the entry. The throttle may be closed at the top of each loop, as appropriate to the subject type, and reopened during each descent. A low powered aircraft would be expected to execute a shallow dive at full throttle in order to pick up speed before commencing the manoeuvre.

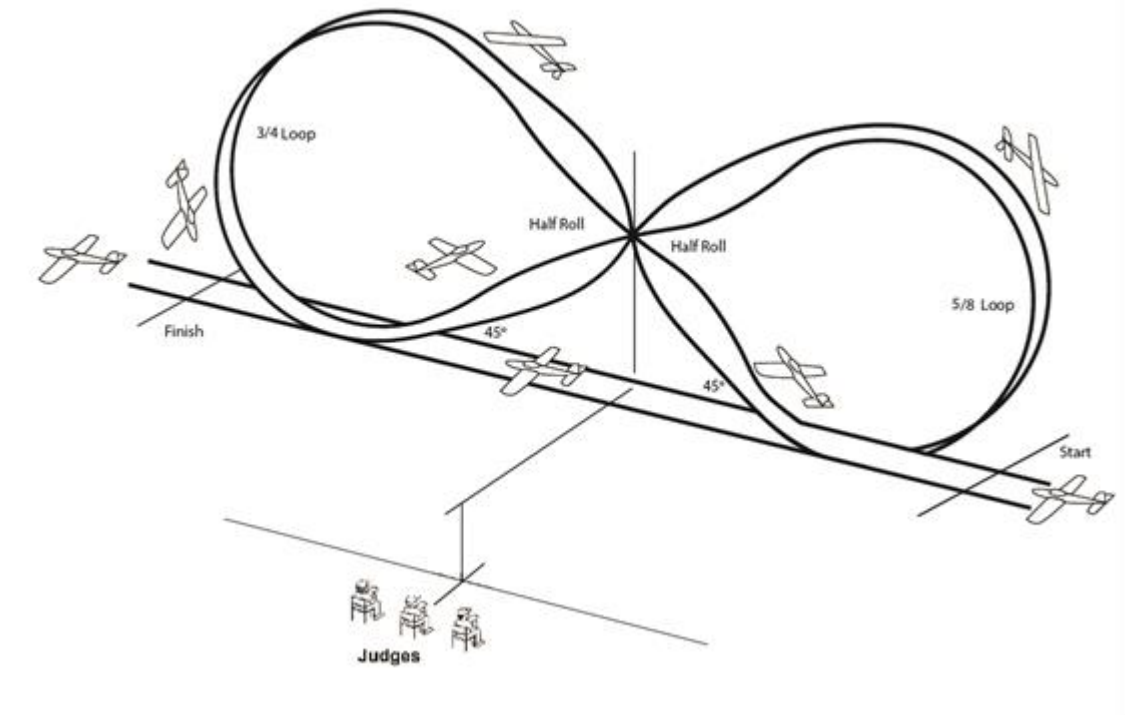

### Errors:

1. Manoeuvre not performed in a constant vertical plane that is parallel with the judges' line.
2. Loops are not circular.
3. Loops are not the same size.
4. Half rolls are not centred on the judges' position.
5. 45° ascent paths not achieved.
6. Model aircraft does not exit manoeuvre at same height as entry.
7. Model aircraft does not resume straight and level flight on same track as entry.
8. Inappropriate use of throttle.
9. Size and speed of manoeuvre not in manner of prototype.
10. Too far away/too close/too high/too low.

**J. Half Cuban Eight:**

The model approaches in straight and level flight on a track parallel to the judges line. After passing the judges centre line the model aircraft pulls up into a 5/8 inside loop until a 45° nose down attitude is reached. The 45° inverted flight is held until a half roll is performed on the judges centre line. The 45° down line is then held until a 1/8th inside loop is performed for a straight and level exit is achieved at the same height and on the same track as the entry. The throttle may be closed at the top of the loop, as appropriate to the subject type, and reopened during the descent. A low powered aircraft would be expected to execute a shallow dive at full throttle in order to pick up speed before commencing the manoeuvre.

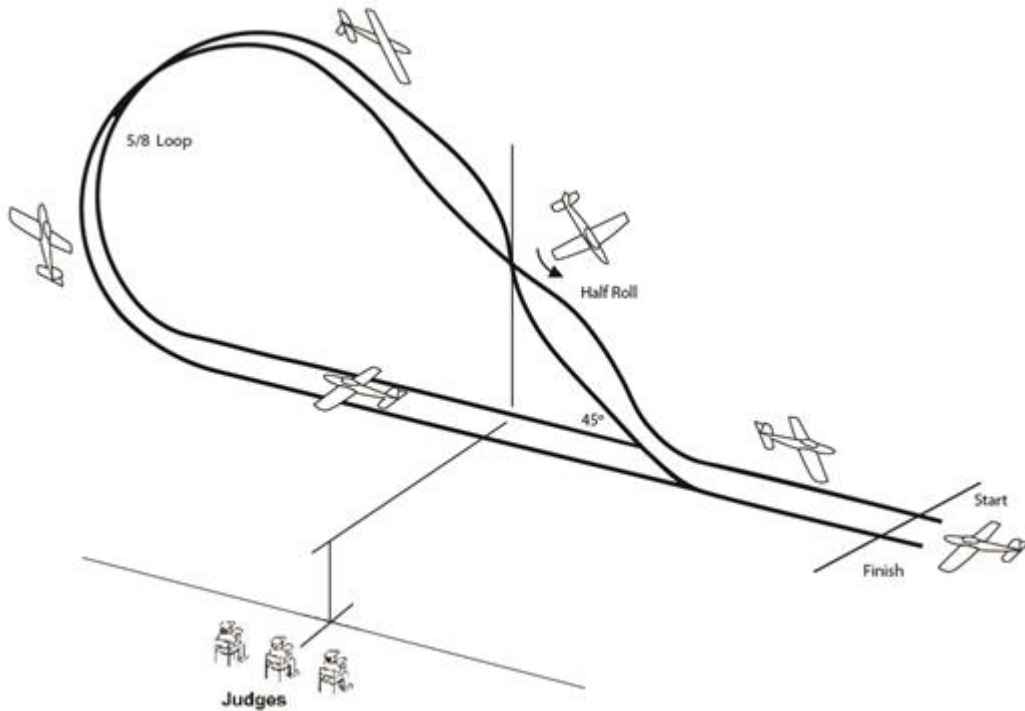
**Errors:**

1. Manoeuvre not performed in a constant vertical plane that is parallel with the judges' line.
2. Loop not circular.
3. Half roll not centred on the judges' position.
4. 45° descent path not achieved.
5. Model aircraft does not exit manoeuvre at same height as entry.
6. Model aircraft does not resume straight and level flight on same track as entry.
7. Inappropriate use of throttle.
8. Size and speed of manoeuvre not in manner of prototype.
9. Too far away/too close/too high/too low.

**K. Half Reverse Cuban Eight:**

The model approaches straight and level, parallel to the runway and pulls through a 1/8 loop into a 45 degree up line before reaching the judges centre line and performs a half roll in front of the judges. It then pulls through a 5/8 inside loop to resume straight and level flight to exit the manoeuvre at the same altitude and opposite track as the entry. The throttle may be closed at the top of the loop, as appropriate to the subject type, and reopened during each descent. A low powered aircraft would be expected to execute a shallow dive at full throttle in order to pick up speed before commencing the manoeuvre.

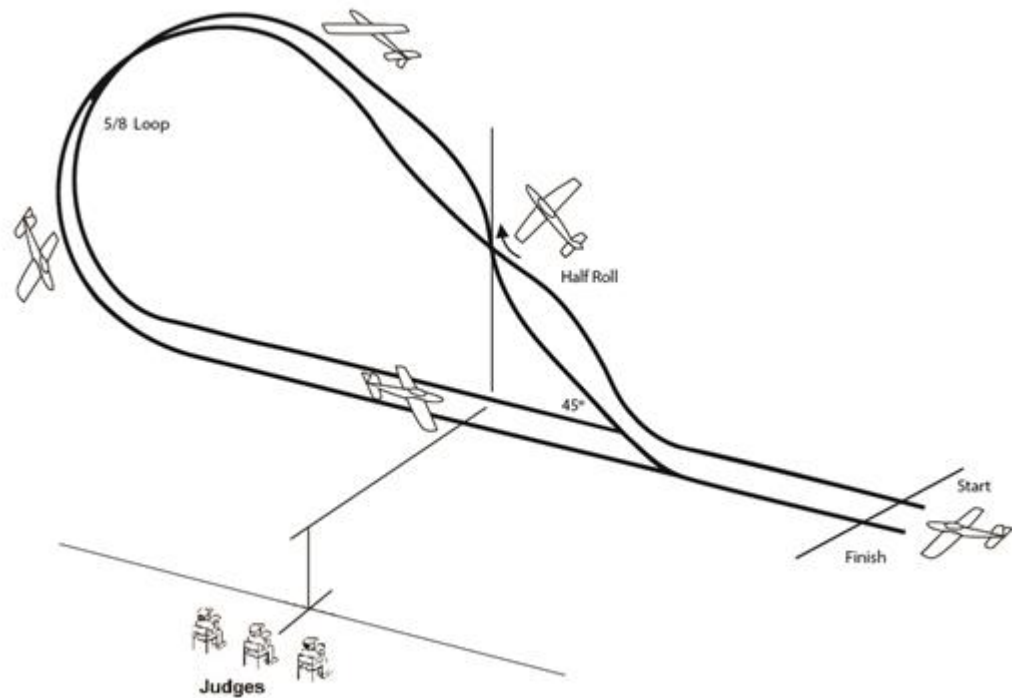
**Errors:**

1. Manoeuvre not performed in a constant vertical plane that is parallel with the judges' line.
2. Loop not circular.
3. Half roll not centred on the judges' position.
4. 45° ascent path not achieved.
5. Model aircraft does not exit manoeuvre at same height as entry.
6. Model aircraft does not resume straight and level flight on same track as entry.
7. Inappropriate use of throttle.
8. Size and speed of manoeuvre not in manner of prototype.
9. Too far away/too close/too high/too low.

**L. Split S (Reversal):**

From straight flight, the model aircraft performs a half roll and when inverted performs half of a circular inside loop (commensurate with the performance of subject type), and resumes straight and level flight on a flight path opposite to that of the entry. The throttle should be closed at the inverted position, as appropriate to type, and opened when normal flight is resumed.

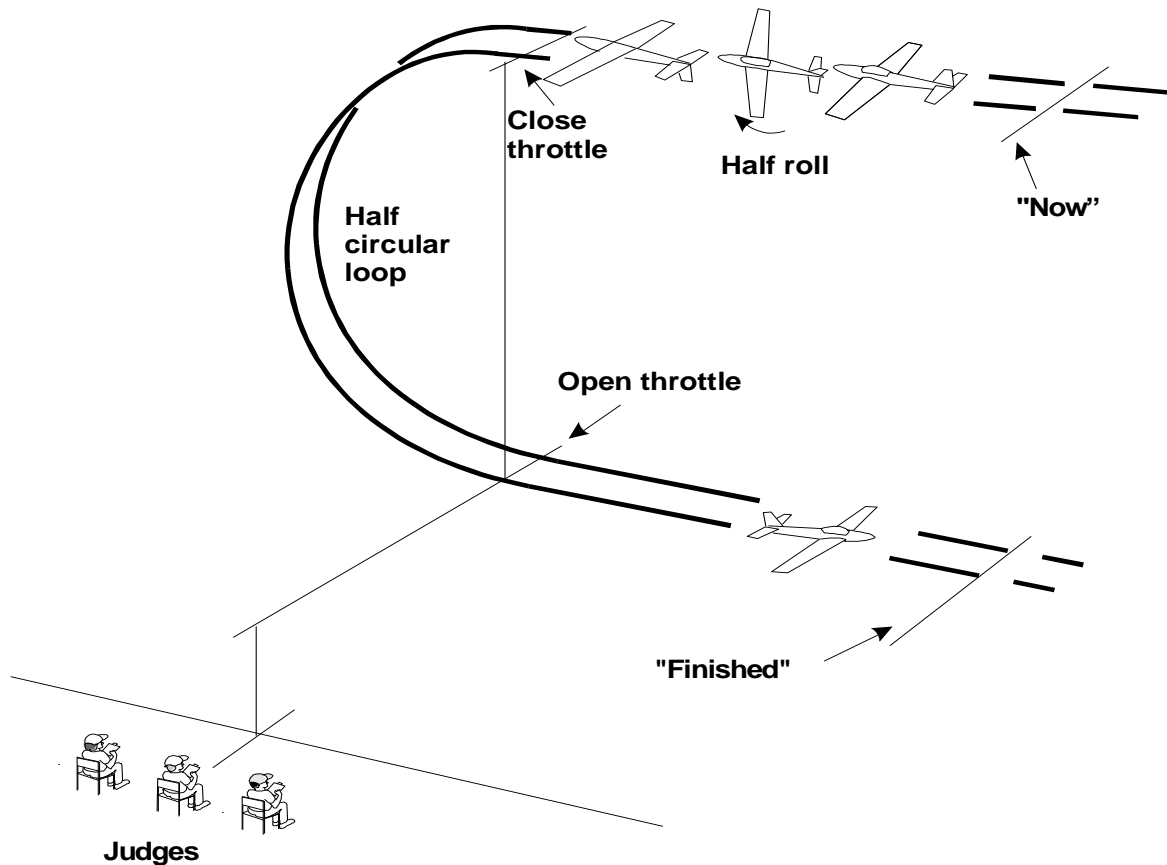
**Errors:**

1. Model aircraft changes track during half roll.
2. Model aircraft inverted too long or too short.
3. Inappropriate use of throttle.
4. Track of half loop not on line or vertical.
5. Half loop is not sufficiently semicircular.
- 6 Too fast or too tight a half loop.
7. Does not resume straight and level flight on opposite track to entry.
8. Half loop not centred on judges' position.
9. Manoeuvre not flown parallel with the judges' line.
10. Too far away/too close/too high/too low.



**M. Spin Three Turns:**

From straight and level flight, the model aircraft decelerates into a stall and commences the spin through three turns and recovers to level flight on the same track as the initial flight direction. During descent the model aircraft may drift with the wind.

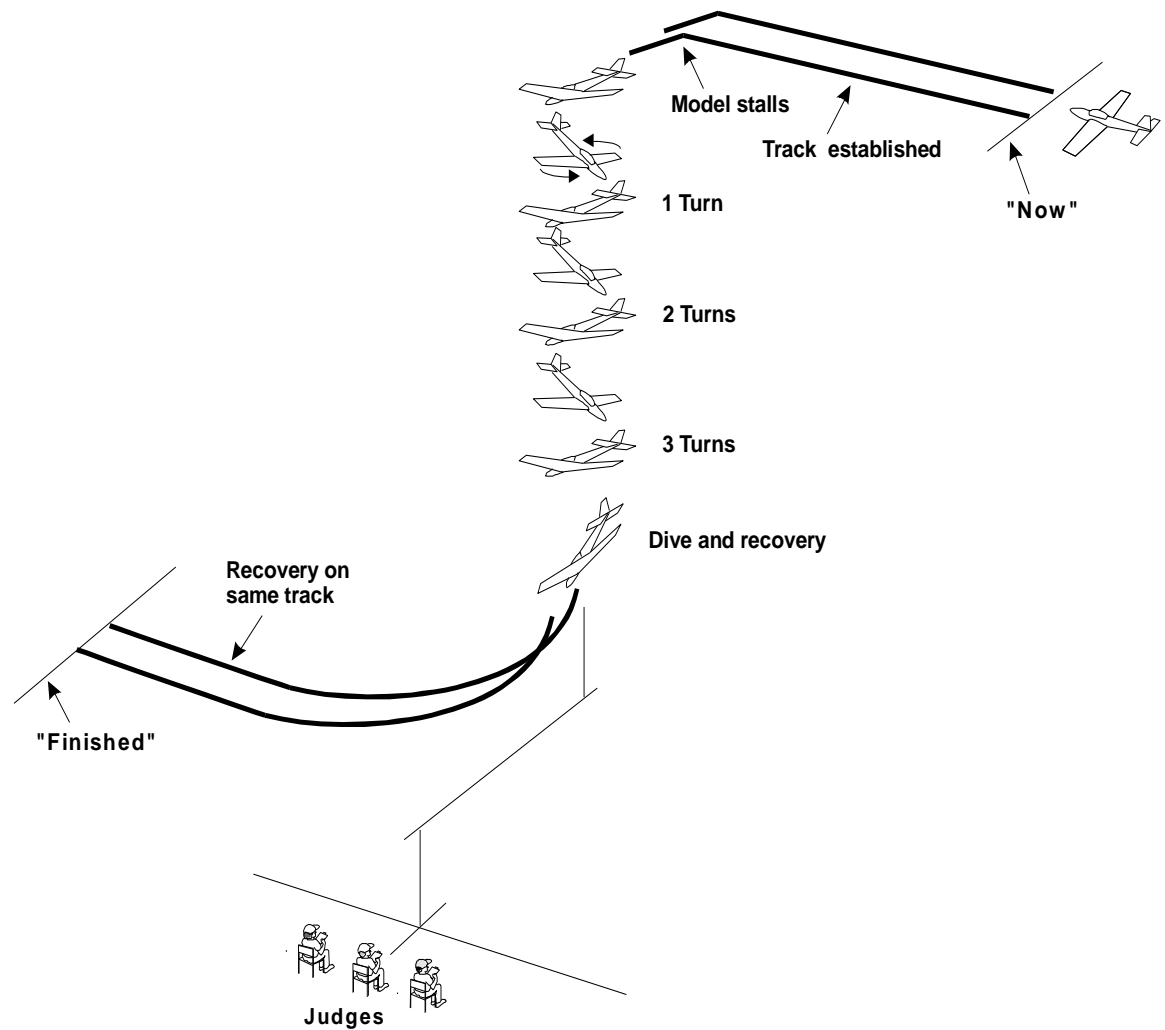

**Errors:**

1. Engine not throttled back at point of stall.
2. Entry into spin not clean and positive.
3. Not a true spin but merely a spiral dive (which should score zero).  
 Note In a true spin descent path will be close to C of G of model aircraft. A spiral dive is a tight vertical barrel roll.
4. Not three complete turns.
5. Start of spin not centred on judges' position.
6. Model aircraft does not resume straight and level flight on same track as entry.
7. Entry and exit paths not parallel with judges' line.
8. Entry and exit not in level flight
9. Too far away/too close/too high/too low.

**N. Roll:**

From straight and level flight, the model aircraft rolls at a constant rate through one complete rotation and resumes straight and level flight on the same track. Low powered aircraft would be expected to execute a shallow dive at full throttle before the manoeuvre. Competitors should nominate any special type of roll that will be performed, eg Slow, Barrel, Snap.

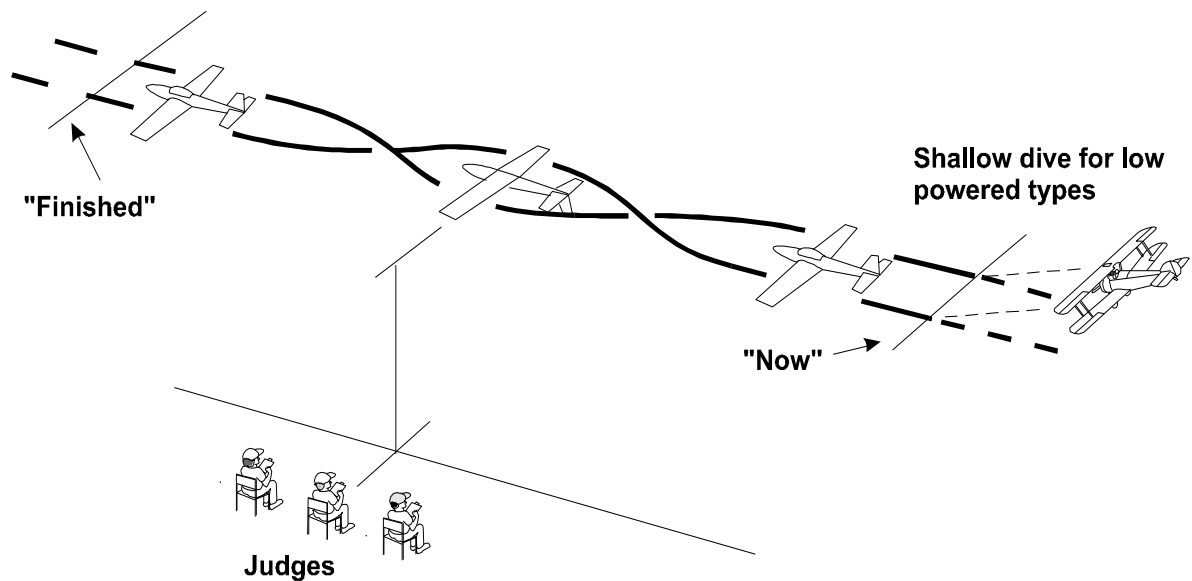
**Errors:**

1. Rate of roll is not constant.
2. Style of roll not typical to prototype.
3. Roll not centred on judges' position.
4. Entry and exit at different heights.
5. Entry and exit at different speeds.
6. Entry and exit tracks and line of roll not parallel with judges' line.
7. Does not resume straight and level flight on same track as entry.
8. Style of roll not as nominated.
9. Inappropriate use of throttle.
10. Too far away/too close/too high/too low.

**O. Parachute:**

The drop should be in the manner of the prototype. For example, cargo should be dropped from a hatch or bomb bays. Man via doors, hatch or by inverting the aircraft. The model aircraft should reduce speed before commencing drop, possibly by using flaps and lowering the landing gear. If the prototype used a braking parachute in landing, the competitor may demonstrate this.

**P. Touch and Go:**

The model aircraft commences by descending from base leg, which may be either curved or straight as required by the pilot. The turn is continued through 90 degrees onto final approach. The model aircraft then lands and takes off again into wind without coming to a halt. The main wheels must roll on the ground for a minimum of five metres. Flaps will be used if applicable.

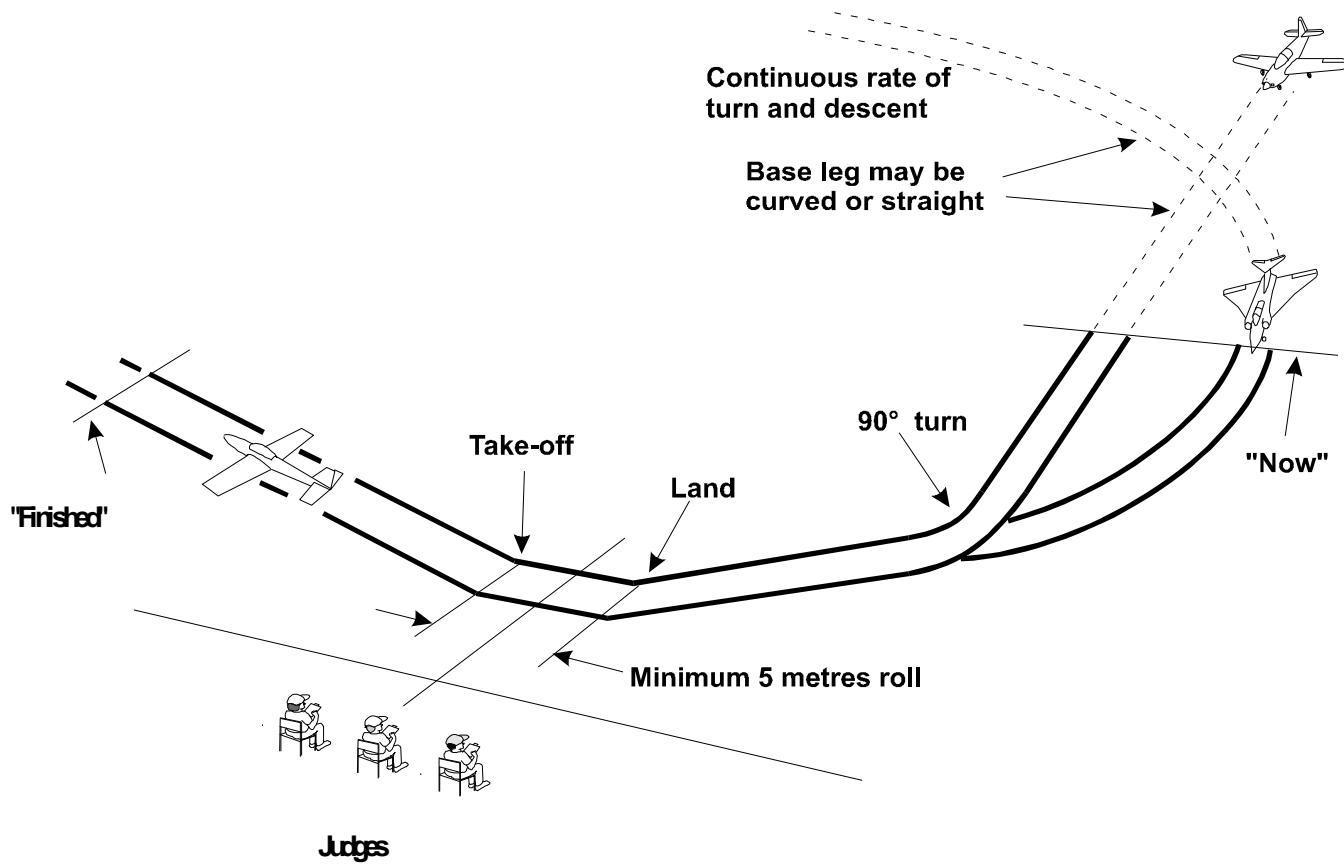

Errors:

1. Manoeuvre does not commence on base leg.
2. Turn onto final approach too tight or not 90°.
3. Descent from base leg not smooth and continuous.
4. Model aircraft does not achieve correct landing approach prior to touchdown.
5. Model aircraft does not achieve a minimum ground roll of 5 metres.

Note: if prototype has two main wheels then both wheels must roll on ground for a minimum 5 metres.

6. Model aircraft bounces on landing.
7. Inappropriate use of flaps.
8. Climb out not smooth or realistic.
9. Approach and climb out tracks not the same.
10. Does not make best use of landing space available for wind direction.

**Q. Overshoot:**

The model aircraft commences by descending from base leg, which may be either curved or straight as required by the pilot. The turn is continued through 90 degrees onto a higher than normal landing approach on low throttle, using flaps if applicable. On reaching the centre of the landing area at a height of approximately 3 metres, power is applied to check the descent. After normal flying speed and attitude are attained the model aircraft climbs straight ahead. The aim of the manoeuvre is to simulate an aborted landing due to a higher than normal landing approach.

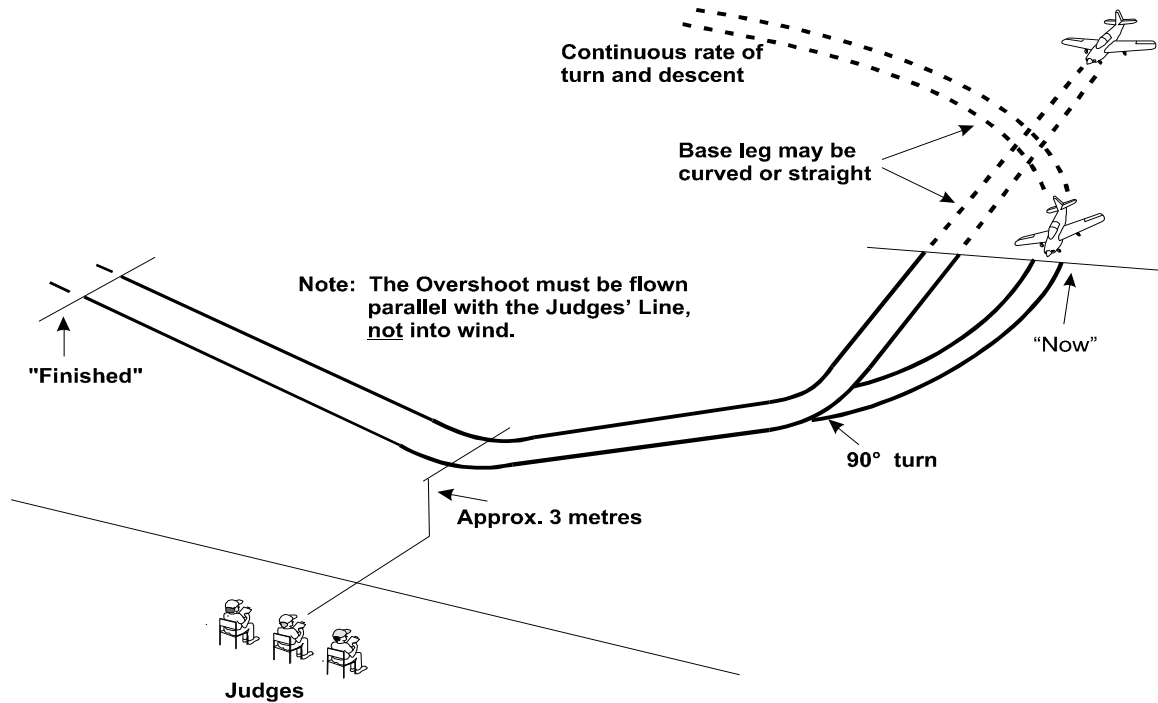
**Errors:**

1. Manoeuvre does not commence on base leg.
2. Turn onto final approach not smooth and continuous or not 90°.
3. Model aircraft does not achieve correct high landing approach.
4. Model aircraft does not achieve correct landing speed or attitude.
5. Not continually descending until power applied.
6. Model aircraft descends to significantly above or below 3 metres.
7. Lowest point of manoeuvre not achieved in front of judges.
8. Not smooth transition of speed & attitude from approach, through descent check to climb-out.
9. Inappropriate use of flap and/or gear.
10. Model aircraft could have landed from approach.
11. Model aircraft does not climb away smoothly.
12. Approach and climb out tracks not the same.
13. Too close or too far away.

**R. Side Slip:**

The model aircraft commences the manoeuvre in level flight by reducing power on base leg, and then turns onto a higher than normal final approach that is parallel with the judges' line. As the model aircraft enters the turn it starts a Sideslip by the application of opposite rudder to the direction of turn, achieving a yaw of at least 20° off track. A marked loss of height must be apparent whilst maintaining final approach speed. The aim of the Sideslip, if continued, would be to effect a landing in front of the judges. Before reaching the judges' position however, the Sideslip is corrected, normal flight is resumed and the model aircraft carries out an overshoot from below 5 metres before climbing away. The purpose of this manoeuvre is to demonstrate a marked loss of height on final approach without an excessive build up of speed or the use of flap.

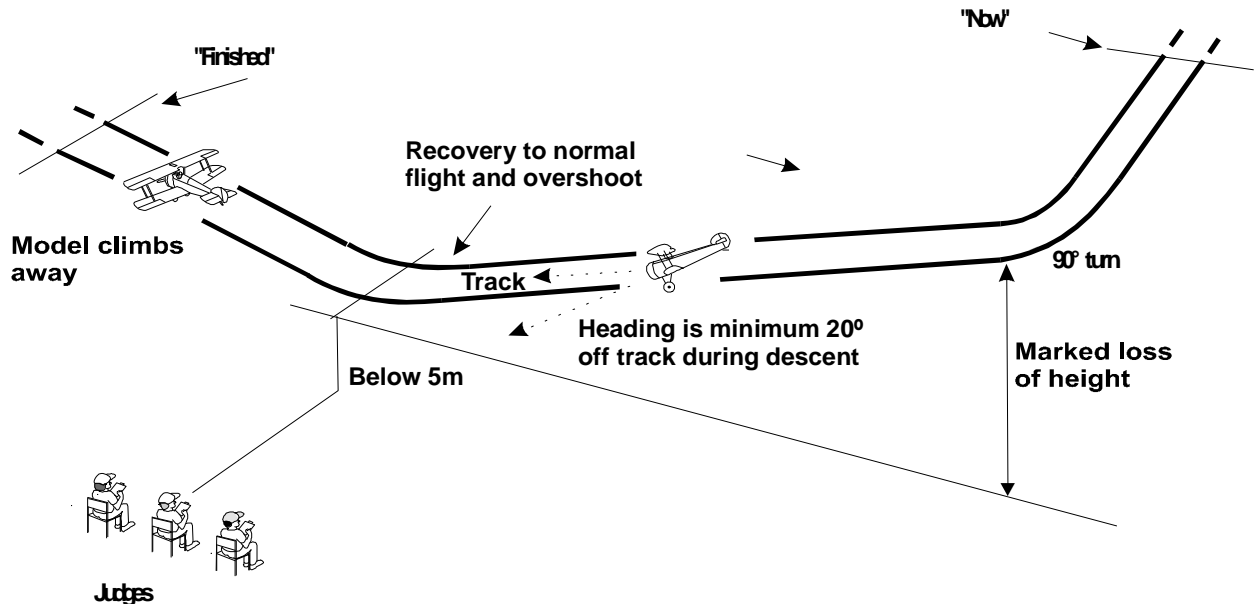
**Errors**

1. Model aircraft does not smoothly enter Sideslip upon turning final approach.
2. Model aircraft is not yawed at least 20° off track during Sideslip.
3. Rate of Sideslip and descent are not constant.
4. There is insufficient height loss.
5. Excessive speed is built up during descent.
6. Approach track not maintained or not flown parallel with judges' line.
7. The Sideslip is not corrected before passing the judges.
8. Overshoot is not below 5 metres.
9. Not a smooth transition during return to normal flight and climb-out.
10. Too far away/too close/too high/too low.

**S. and T. Flight Function(s) Performed by Prototype Aircraft:**

A competitor may demonstrate up to two different flight functions of his own choice but must indicate to the flight judges the nature of the demonstration(s) before going to the flight line. The competitor must be prepared to supply evidence that the aircraft performed this function subject type modelled, eg crop spraying, outside loop etc.

Procedural flying manoeuvres such as procedure turn, climbing turn, descending turn, etc are not acceptable. Mechanical options, which could be equally performed on the ground (eg switching on and off lights), are also not allowed.

**U. Flight in Triangular Circuit:**

The model aircraft approaches in a straight and level flight to a point directly in front of the judges. It then turns away to track  $60^\circ$  away from the judges' line. It then flies straight and level for a minimum of 150 metres, turns to track parallel with the judges' line, flies a further minimum of 150 metres, then turns to track towards the judges and flies a further minimum of 150 metres to a position above the centre of the landing area, which completes an equilateral triangle (i.e. a triangle with sides of equal length and angles of  $60^\circ$ ), before making a final turn to intercept the original entry track.

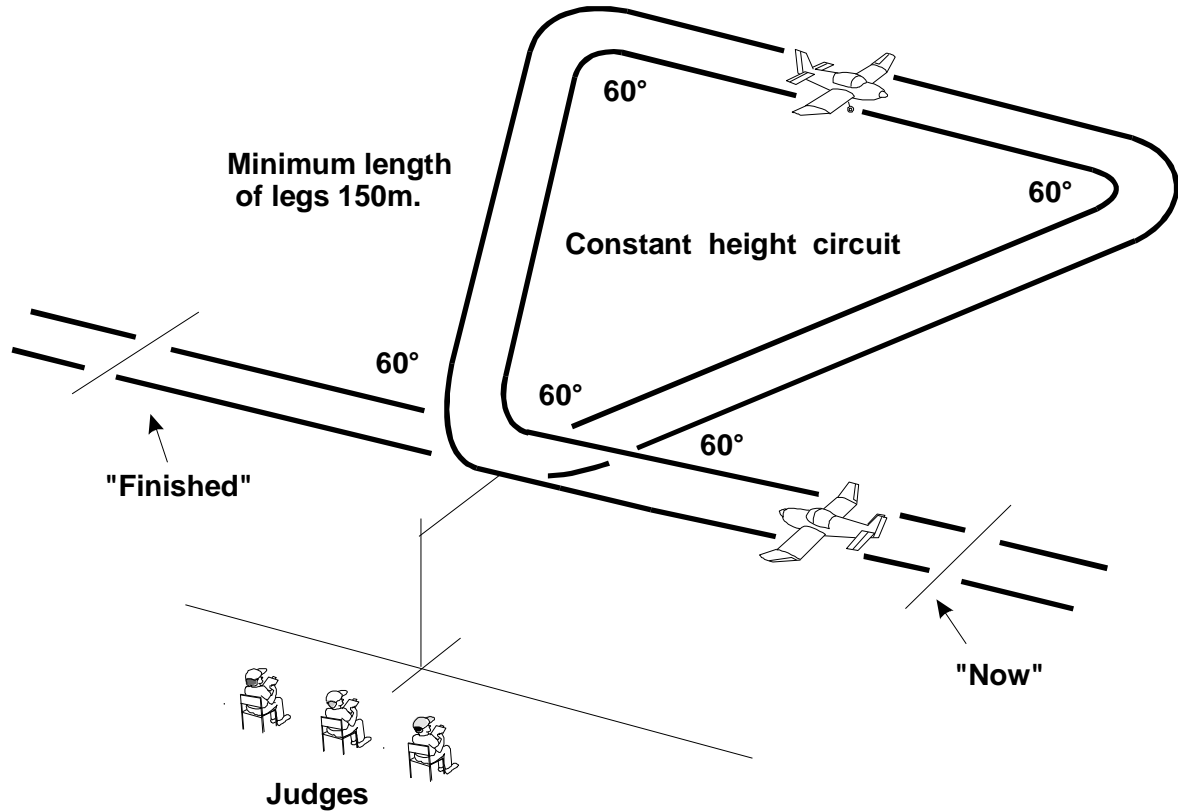
**Errors:**

1. Not commenced and finished at points equidistant from the judges.
2. Model aircraft changes height.
3. Rate of turn at corners not constant or inside corners of triangle not  $60^\circ$ .
4. Sides of the triangle are not straight.
5. Sides of triangle are not equal lengths.
6. Sides of the triangle are too long or too short.
7. Apex of triangle not centred on judges' position.
8. Correction for drift not properly made.
9. Start and finish tracks not the same.
10. Start and finish tracks not parallel with judges' line.
11. Too far away/too close/too high/too low.

**V. Flight in Rectangular Circuit:**

The model aircraft approaches in straight level flight to a point directly in front of the judges. It then continues for a minimum of 75 metres before it turns away to track  $90^\circ$  from the judges' line and flies straight and level for a minimum of 150 metres before turning to track parallel with the judges' line for a further minimum of 75 metres. It then turns to track directly towards the judges for a minimum of 150 metres, to a point in front of the judges, before completing a final turn to intercept the original entry track. This manoeuvre describes a rectangle over the ground.

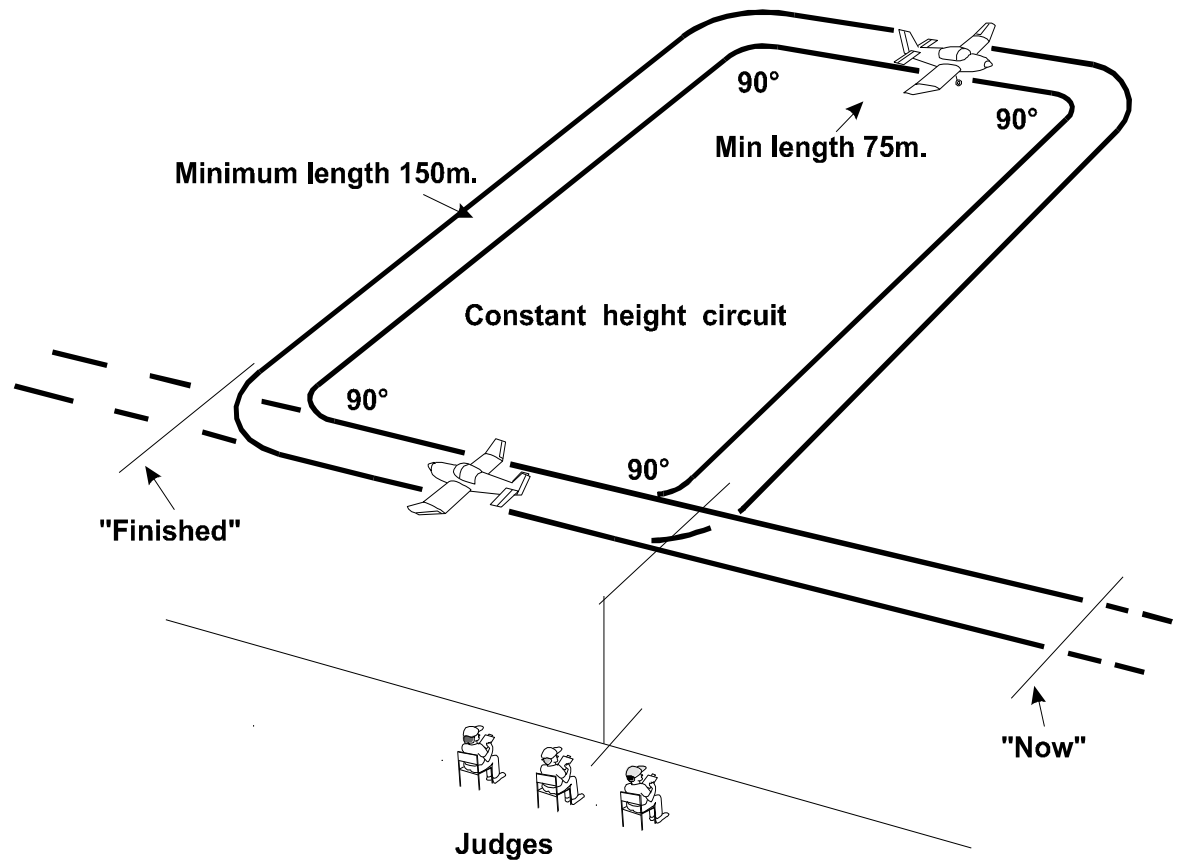
**Errors:**

1. Not commenced and finished at points equidistant from the judges.
2. Model aircraft changes height.
3. Rate of turn at corners not constant or corners not  $90^\circ$ .
4. Legs are not straight.
5. Legs too long or too short.
6. Opposite sides of rectangle are not of equal length
7. Correction for drift not properly made.
8. Final leg of rectangle not centred on judges' position.
9. Start and finish tracks not the same.
10. Start and finish tracks not parallel with judges' line.
11. Too far away/too close/too high/too low.

**W. Flight in a Straight Line at Constant Height (Maximum 6 m):**

Model aircraft approaches in straight flight at a constant height not exceeding 6 metres for a minimum distance of 100 metres, then climbs away. This is in effect a low flypast.

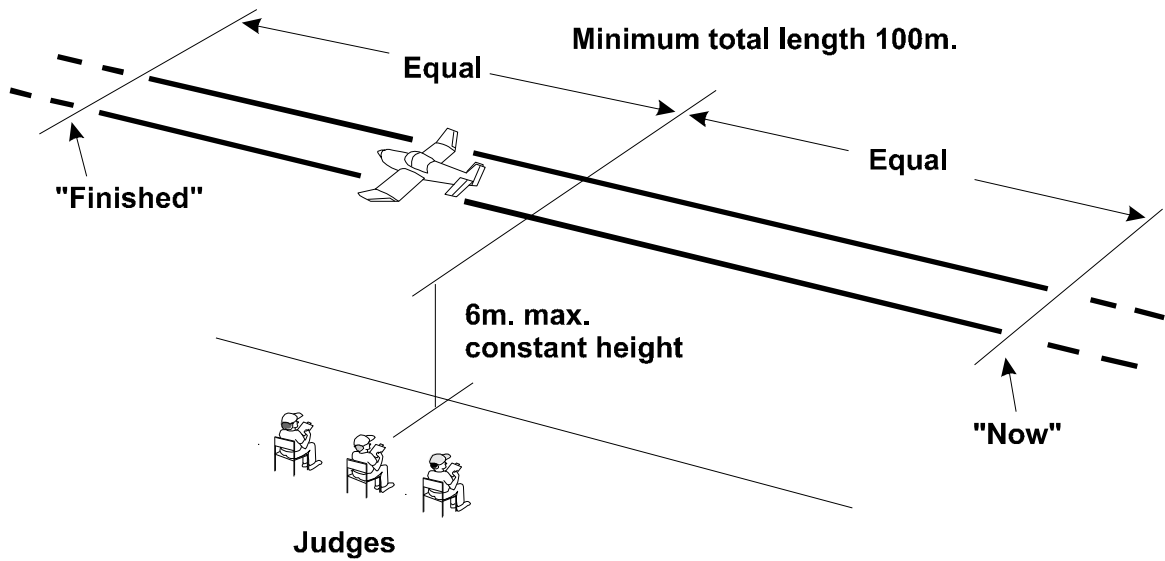

Errors:

1. Not a straight course (slight corrections acceptable with light aircraft).
2. Not constant height.
3. Not 6 metres or below.
4. Not pass over the landing area.
5. Not centred on judges' position.
6. Not parallel with the judges' line.
7. Too short distance (too long is not an error).
8. Model aircraft flight path not steady.
9. Too far away/too close/too high/too low.



**X. Flight in a Straight Line With One Engine Throttled:**

Model aircraft approaches in straight flight at a constant height with one engine throttled, for a minimum of 100 metres, after which the engine is opened up and the model aircraft resumes normal flight. (This option is only for multi-engined subjects.)

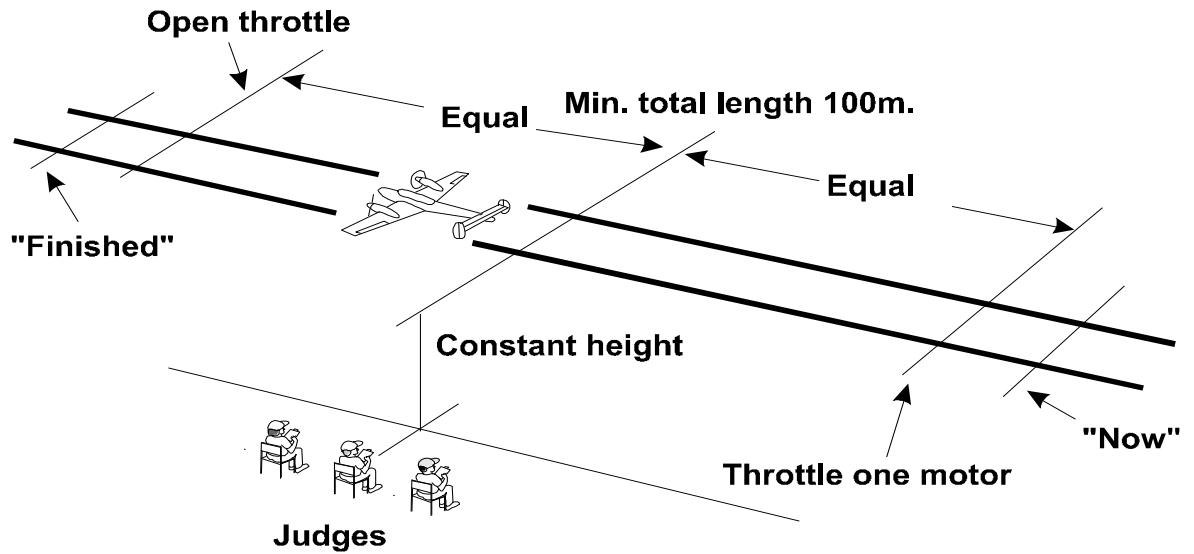

Errors:

1. Flight not straight.
2. Model aircraft is unstable.
3. Undue loss of height.
4. Engine not opened up after demo.
5. Engine not throttled back sufficiently.
6. Insufficient duration.
7. Not centred in front of judges' position.
8. Not flown parallel with the judges' line
9. Too far away/too close/too high/too low.

## Y. Lazy Eight

The model aircraft approaches in straight and level flight on a line parallel with the Judges' line. When the model aircraft is in line with the judges (the centre) a smooth curving climb is commenced which progresses to a smooth climbing turn of constant radius away from the judges. At the apex of the turn the bank should be at least  $60^\circ$  and the model aircraft shall be on a heading of  $90^\circ$  to the judges' line. The nose of the model aircraft then lowers and the bank comes off at the same rate as it went on. The turn is continued beyond  $180^\circ$  to intercept the centre with the wings level and at the same height as the entry height into the manoeuvre.

At the centre another smooth climbing turn, the shape of which should be the same as the first turn, is immediately commenced away from the judges. The second turn is then continued beyond  $180^\circ$  to cross the centre with the wings level and at the same height as the entry into the manoeuvre. The Lazy Eight is completed by maintaining this height and heading with wings level before turning to intercept the original approach track to exit the manoeuvre parallel to the judges' line in straight and level flight. A low powered aircraft would be expected to execute a shallow dive at full throttle in order to pick up speed before commencing the manoeuvre. The figure should be symmetrical each side of the judges' position.

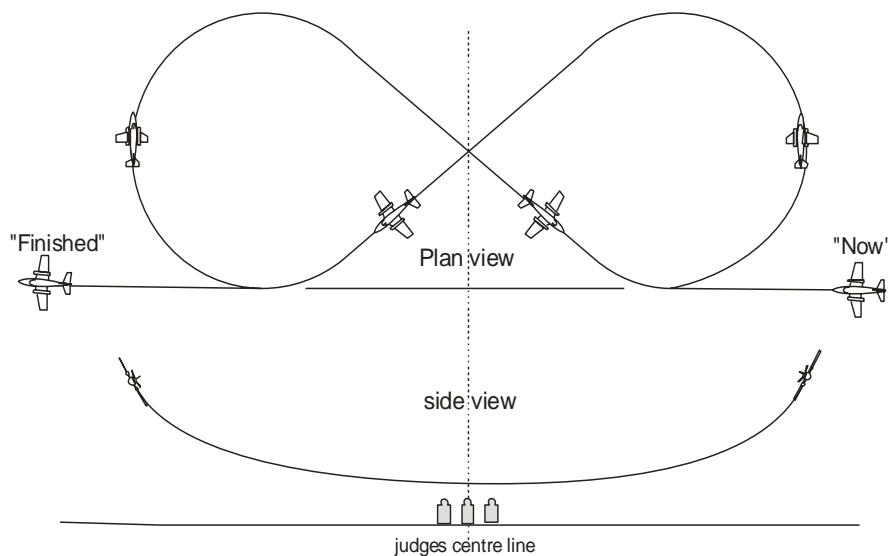

### Errors:

- 1 Entry and exit paths not parallel with judges' line.
2. Insufficient climb achieved.
- 3 Insufficient bank achieved.
- 4 Climb and descent angles not equal throughout manoeuvre.
5. Manoeuvre not symmetrical about judges' position.
6. Arcs misshapen.
7. Start and finish positions not as indicated.
8. Overall size of manoeuvre not realistic for prototype.
9. Model aircraft flight path not smooth and steady.
- 10 Too far away/too close/too high/too low.

## Z. Wingover.

The model aircraft approaches in straight and level flight on a line parallel with the Judges' line. After passing the judges' position a smooth climbing turn is commenced away from the judges. At the apex of the turn, the model should track 90° to the entry track and the bank angle should be appropriate to the capability of the prototype, but usually no more than 60° for a non-aerobatic model and at least 60° for an aerobatic model. The height gain should be appropriate to the capability of the prototype. The model then continues on a mirror image of the entry flight path and recovers to straight and level flight at the same height but on the opposite heading to the entry and on a line displaced away from the judges.

A low powered aircraft would be expected to execute a shallow dive at full throttle in order to pick up speed before commencing the manoeuvre.

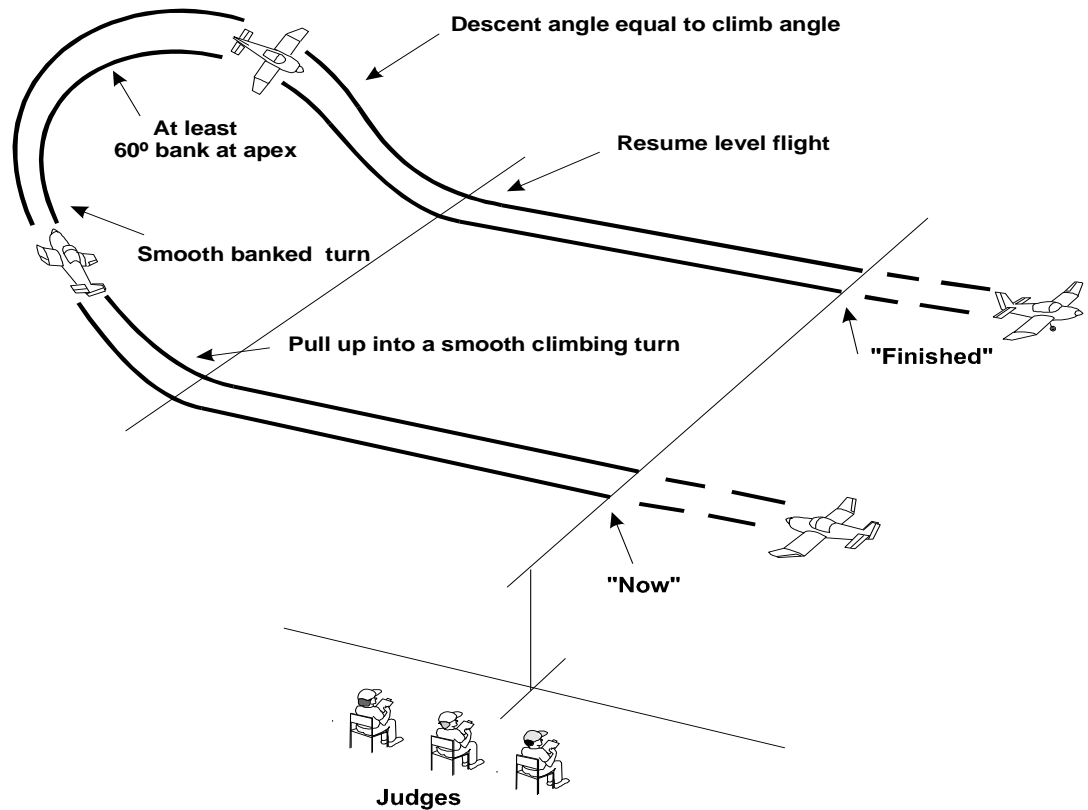

### Errors:

1. Start and finish positions not as indicated.
2. Insufficient climb achieved.
3. Insufficient bank achieved
4. Climb and descent angles not equal throughout manoeuvre.
5. Model aircraft does not fly a smooth and symmetrical arc.
6. Entry and exit paths not parallel with judges' line.
7. Overall size of manoeuvre not realistic for prototype.
8. Model aircraft flight path not smooth and steady.
9. Too far away/too close/too high/too low.

**AA. Inverted Flight.**

Model aircraft half rolls into inverted attitude and makes a straight inverted flight of 100 metres in length, and then half rolls out of inverted attitude and resumes normal straight flight. A low powered aircraft would be expected to execute a shallow dive at full throttle in order to pick up speed before commencing the manoeuvre.

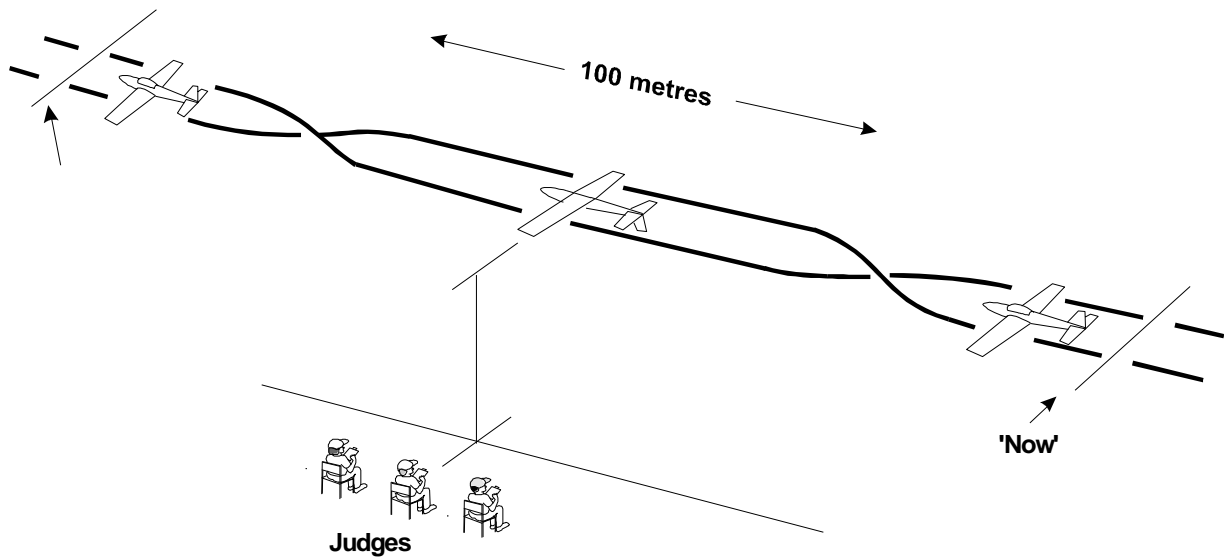
**Errors:**

1. Half rolls not performed on same track as inverted flight.
2. Model aircraft does not fly a straight course.
3. Model aircraft gains or loses height.
4. Model aircraft does not remain inverted for the prescribed duration.
5. Manoeuvre not centred on judges' position.
6. Manoeuvre not flown parallel with judges' line.
7. Too far away/too close/too high/too low.

**AB. Derry Turn**

The model approaches at a high speed in straight and level flight on a line parallel with the judge's line. The model aircraft then makes a steep (in excess of  $60^\circ$  bank) one quarter circle turn in a direction away from the judges, without losing height. When centred in front of the judges the model aircraft makes a half roll in the same rolling direction as the entry, again directly followed by a steep one quarter circle turn in the opposite direction, and then flies off straight and level on a line parallel with that of the entry to the manoeuvre. The manoeuvre should be smooth and continuous.

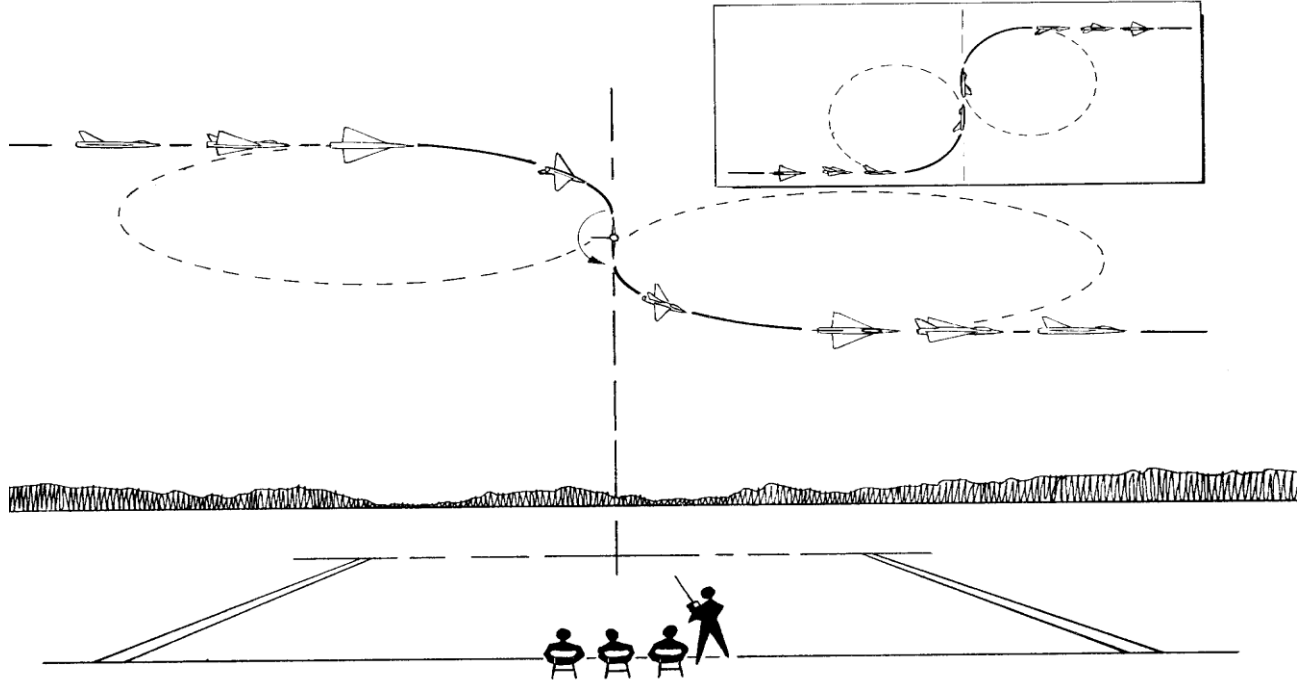
**Errors**

- 1) Entry not in parallel with the judges' line.
- 2) The manoeuvre not centred in front of the judges.
- 3) The rolling manoeuvre in front of the judges not axial.
- 4) The roll in centre not in the same direction as the entry to the manoeuvre.
- 5) The roll not carried out on a line directly away from the judges.
- 6) Any hesitation between the end of the first quarter turn, the roll and/or the start of the second turn.
- 7) Exit not parallel with entry.
- 8) Significant height difference during the manoeuvre.
- 9) The manoeuvre misshapen as seen as part of a figure eight.
- 10) The manoeuvre is executed too low or too high to be easily judged.

**AC. Procedure Turn**

Commencing from straight and level flight the model aircraft must turn through 90° in a direction away from the judges and then turn through 270° in the opposite direction, resuming straight and level flight on the opposite heading to that of the entry. The manoeuvre must be commenced so as to place the point where the model aircraft changes from the 90° turn to the 270° on a line which is at a right angle to the direction of entry and passes through the centre of the judges' position.

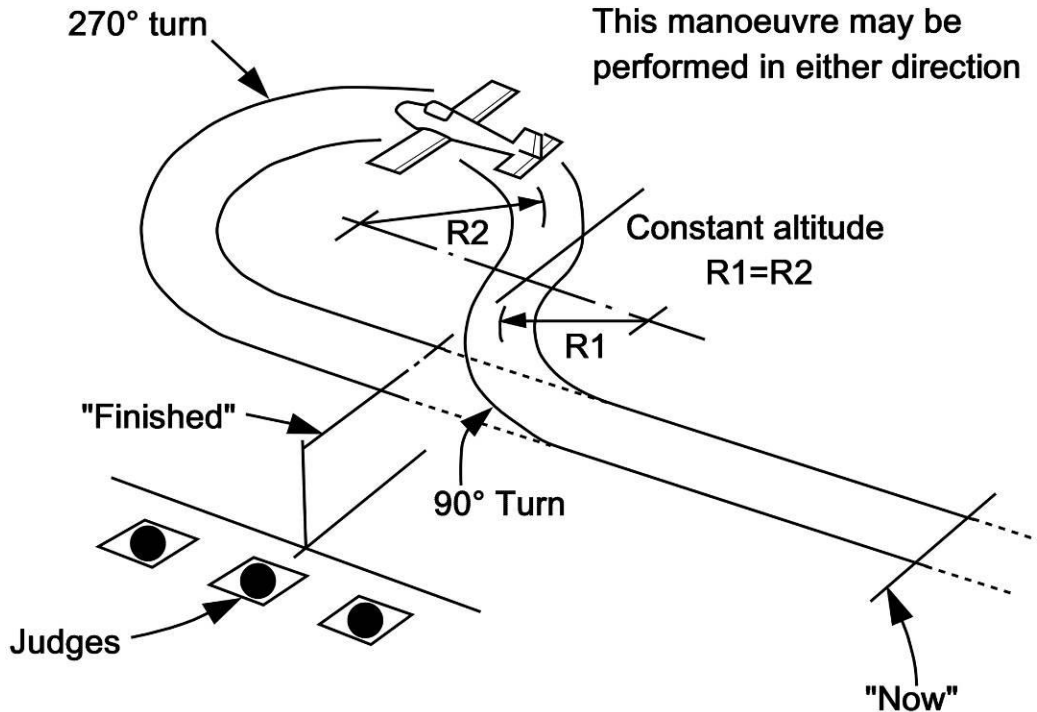
**Errors:**

1. Rate of turn is not constant.
2. The model aircraft changes altitude during the manoeuvre.
3. The model aircraft does not resume straight and level flight on the correct heading.
4. The model aircraft does not change from 90° to the 270° turn at the correct position.
5. The manoeuvre is too small or too large in reference to the type and scale of the model aircraft.
6. The manoeuvre is too close or too far away to be observed properly.
7. The manoeuvre is too high or too low to be observed properly.

**AD. Straight Flight at Low Speed**

The model flies in a straight line, and parallel with the judges line, over the landing area for a minimum distance of 100 meters and centred on the judges position. The height must be constant and not exceed 6 metres and the model must fly at a speed which would represent the minimum safe flying speed for the prototype.

Prototypes fitted with retractable undercarriage must have the U/C extended.

If the prototype is fitted with any L/E or T/E flaps, slats, speed brakes, spoilers or other high drag/low speed/high lift devices then these must be deployed, unless the competitor can provide evidence that such devices were disabled or not routinely used.

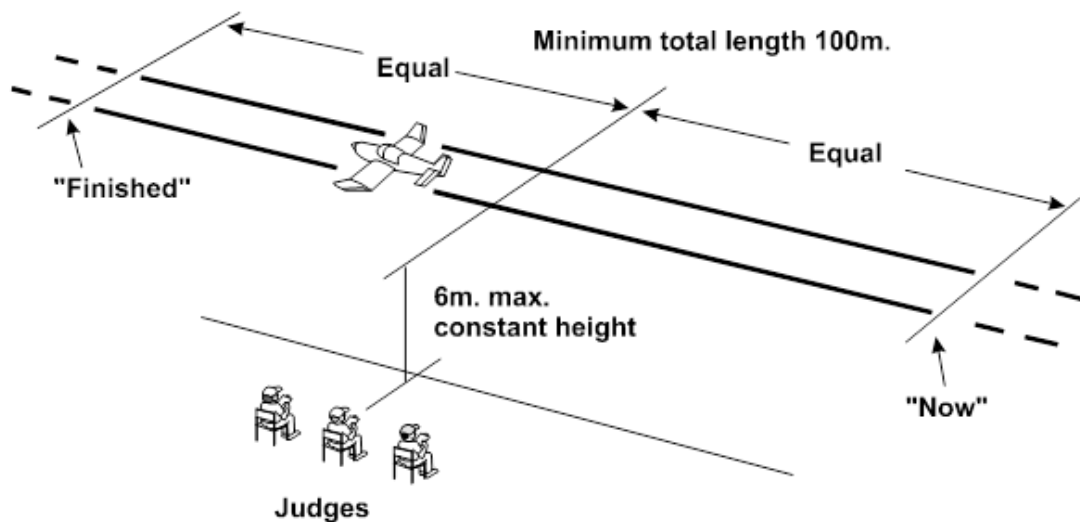
**Errors:**

1. Not a constant heading
2. Not a constant height.
3. Above 6 metres.
4. Model does not pass over the landing area.
6. Manoeuvre not centred on judges' position.
7. Not parallel with the judges' line.
8. Too short distance (too long is not an error).
9. Failure to extend U/C or deploy high drag/low speed/high lift devices.
10. Model flying too fast.

## ANNEX 6D

### CLASS F4A (PROVISIONAL) JUDGES' GUIDE - OUTDOOR FREE FLIGHT POWER SCALE CLASS

**6.D.1** Model aircraft should at all times fly in the same manner as the prototype. The following notes describe an average aeroplane; judges should use their own personal judgement to decide on an appropriate flight style for the prototype submitted and mark the flight accordingly. Competitors may submit a description of the prototype flight characteristics (originated by a competent authority), which should be used to judge the flight.

**6.D.2. Take Off**

The model aircraft should slowly accelerate from rest, leaving the ground after an appropriate ground run. The take-off run should be straight, and transition to flight should be smooth.

Errors

The take-off should be penalised if: the ground run is too short, too long or assisted, the tail or nose wheel does not leave the ground before the main wheels, the wing drops or the run is curved

Note: That a swing may occur as the tail wheel leaves the ground; this is normal and should not be penalised unless it is excessive.

**6.D.3. Initial Climb**

The model aircraft should smoothly rotate to a climbing attitude, and commence a gentle straight or curved climb. The climb should be smooth and appropriate to the prototype.

Errors

The climb should be penalised if: too steep, too shallow, too highly banked, wing drop or wing rock occurs or nose attitude is too high or too low.

Note: That a high bank steep spiral climb is normal for a Pitts but that a Bleriot should hardly leave ground effect.

**6.D.4. Realism in Flight**

The model aircraft should mirror the flight characteristics of the prototype in speed, flight attitude, stability and balance. The model aircraft may fly in a straight line or turn in either or both directions. Turns should display an appropriate amount of bank. The flight should be smooth and continuous, especially the transitions between take-off, climb, cruise, descent and landing approach. Due allowance must be made for the prevailing wind conditions.

Errors

Realism in flight should be penalised if: the model aircraft flies too slowly or too fast, the nose attitude is too high or too low, the model aircraft stalls, or shows an erratic flight path, has persistent wing drop or wing rock, flies an out of balance turn or pitches harshly on engine failure. A stall or wing drop may occur if the model aircraft hits turbulence or its own slipstream. If the recovery to stable flight is smooth, this should not be penalised. A grossly out of balance turn, left turn with right bank for instance, or a flat turn should be penalised.

**6.D.5. Transition to Descent**

The model aircraft's flight path should smoothly change between cruise and descent. The change may be abrupt, after an engine failure, or prolonged as the power slowly reduces. The direction of flight may or may not change.

Errors

The transition should be penalised if: the model aircraft stalls as the engine fails, wing drop or wing rock occurs or an excessive pitch change is apparent.

*cont/...*



#### **6.D.6. Descent and Landing Approach**

The descent should be smooth, continuous and stable. It may be straight or curved. The angle of descent should be consistent with that of the prototype either engine on or engine off. As the model aircraft nears the ground, it should adopt a landing attitude consistent with that of the prototype. Allowance must be made for prevailing wind conditions.

##### **Errors**

The descent and landing approach should be penalised if: the model aircraft stalls, drops or rocks the wings, shows too steep a glide or does not change to a landing attitude.

Note: That the glide angle may change significantly with engine on or off.

## ANNEX 6E

# FORM(S) FOR USE IN SCALE MODEL AIRCRAFT CONTESTS

## CLASSES F4B, F4C, F4G, F4H and F4K

### Forms:

Annex 6E.1: Competitors Declaration Form

Annex 6E.2: F4H Static Score Sheet

Annex 6E.3: F4C, F4G and F4K Static Score Sheet

Annex 6E.4: F4C, F4G and F4H Flight Score Sheet

Annex 6E.5: F4K Flight Score Sheet

*Note: These forms are available for download from the “Documents” section of the CIAM website <http://www.fai.org/ciam-documents>.*

CHAMPIONSHIP LOGO and FAI emblem

### COMPETITORS DECLARATION FORM (ANNEX 6E.1)

This form must be completed and signed by the competitor and endorsed by the competitor's NAC. Competitors are to indicate answers YES or NO by circling the appropriate boxes.

Competitor's Name	National Identification.	Prototype Name & Designation	Class:F4C,F4G, F4H or F4K
-------------------	--------------------------	------------------------------	---------------------------

If your flight schedule is to include Optional Demonstrations 6.3.7. S or T - Flight functions by subject aircraft: Provide full details of your manoeuvre(s) here or on a separate sheet.

Empty box for providing details of manoeuvres.

AIRCRAFT CRUISING OR MAXIMUM SPEED – attach proof on a separate sheet.

Empty box for attaching proof of cruising or maximum speed.

**Annex 6E.1 .../cont**

<b>STATIC JUDGING QUESTIONNAIRE ...continued</b>		
Was the structure of this model researched and designed entirely by you?	YES	NO
Was this model built using a commercially available design or plan? If YES state the name of the person who has drawn the plan.	YES	NO
Was this model built from a kit? If YES, state kit manufacturer's name:	YES	NO

**Indicate if any of the following items are supplied as part of a kit or not made by you. List any additional items (other than R/C equipment) in the empty spaces or on a separate sheet. (Refer to Rule 6.1.13)**

Moulded or built up fuselage	YES	NO
Pre-formed or built up wing panels	YES	NO
Pre-formed or built up tail surfaces	YES	NO
Moulded canopy	YES	NO
Moulded or spun engine cowlings	YES	NO
Undercarriage assembly	YES	NO
Wheels	YES	NO
Tyres	YES	NO
Guns, bombs or other fittings	YES	NO
Spinners	YES	NO
Scale propellers	YES	NO
Instrument panel or cockpit interior	YES	NO
Printed or pre-cut markings or decals	YES	NO
Wire rigging or fittings	YES	NO
	YES	NO
	YES	NO

**COMPETITOR'S CERTIFICATION**

F4B, F4C, F4G, F4K: I certify that I am the builder of the model and that the answers given above are correct.	
Name .....	Signature.....
F4H only – I certify that I applied the colour scheme and markings to the model and the answers given above are correct.	
Name .....	Signature.....

**ENDORSEMENT BY THE COMPETITOR'S NATIONAL AIRSPORTS CONTROL**

I certify that the Competitors Certification is valid and the answers given above have been verified.	
Name .....	Signature.....
Position Held /Authority .....	

CHAMPIONSHIP LOGO and FAI emblem

PROTOTYPE NAME AND DESIGNATION:	CONTESTANT NUMBER:
	CONTESTANT NAME:

# F4H Static Score Sheet

(ANNEX 6E.2)

STATIC JUDGING QUALIFICATION	CLAIMED	AWARDED
3-view (minimum span 250mm Max span 500mm)		
Colour Documentation		
Five photos maximum		
Competitors Declaration Form		

Judge Initials:	Chief Judge Signature:

STATIC SCORE (0-10 Decimals permitted)					
No	ITEM	ASPECT	MARK	K	SCORE
1	SCALE ACCURACY	Side view		13	
2		End view		13	
3		Plan view		13	
4	COLOUR ACCURACY			7	
5	COLOUR COMPLEXITY			3	
6	MARKINGS ACCURACY			10	
7	MARKINGS COMPLEXITY			5	
8	REALISM			16	
9	ORIGINALITY OF DESIGN & CONSTRUCTION			20	
				<b>TOTAL</b>	

CHAMPIONSHIP LOGO and FAI emblem
----------------------------------

PROTOTYPE NAME AND DESIGNATION:	CONTESTANT NUMBER:
	CONTESTANT NAME:

## F4C, F4G and F4K Static Score Sheet

(ANNEX 6E.3)

STATIC JUDGING QUALIFICATION	CLAIMED	AWARDED
3-view (minimum span 250mm; maximum span 500mm)		
Colour Documentation		
Three photos minimum		
Competitors Declaration Form		

Judge Initials:	Chief Judge Signature:

STATIC SCORE (0-10 Decimals permitted)					
No	ITEM	ASPECT	MARK	K	SCORE
1	SCALE ACCURACY	Side view(s)		13	
		End view(s)		13	
		Plan view(s)		13	
2	COLOUR	Accuracy		3	
		Complexity		2	
3	MARKINGS	Accuracy		8	
		Complexity		3	
4	SURFACE TEXTURE & REALISM	Surface Texture		7	
		Realism		7	
5	CRAFTMANSHIP	Quality		12	
		Complexity		5	
6	SCALE DETAIL	Accuracy		9	
		Complexity		5	
				<b>TOTAL</b>	



CHAMPIONSHIP LOGO and FAI emblem

# Flight Score Sheet

## F4C, F4G and F4H

(ANNEX 6E.4)

Competitor number:

Round:

Judge Number:

Competitor  
Name:

Judge Signature:

Prototype Name and Designation:

Cruising /  
Maximum Speed:

Scale of Model:

No.	MANOEUVRES	MARK	K-factor	SCORE
1	Take-off		11	
2	Option 1:		7	
3	Option 2:		7	
4	Option 3:		7	
5	Option 4:		7	
6	Option 5:		7	
7	Option 6:		7	
8	Option 7:		7	
9	Option 8:		7	
10	Approach and Landing		11	
11	Realism in Flight	Flight Presentation	4	
		Speed of the model	9	
		Smoothness of flight	9	
TOTAL				



CHAMPIONSHIP LOGO and FAI emblem

# Flight Score Sheet F4K

(ANNEX 6E.5)

Competitor Number:

Round:

Judge Number:

Competitor  
Name:

Judge Signature:

Prototype Name and Designation:

Cruising /  
Maximum Speed:

Scale of Model:

No.	MANOEUVRES	MARK	K-factor	SCORE
1	Take-off		14	
2	Option 1:		10	
3	Option 2:		10	
4	Option 3:		10	
5	Option 4:		10	
6	Option 5:		10	
10	Approach and Landing		14	
11	Realism in Flight	Flight Presentation	4	
		Speed of the model	9	
		Smoothness of flight	9	
<b>TOTAL</b>				

**PAGE DELIBERATELY LEFT BLANK**

**ANNEX 6F****F4H - JUDGES GUIDE FOR STATIC JUDGING****6F.1 General**

- a) As with other scale classes, before individual judging commences, all the models entered should be reviewed in order to superficially grade the models in relation to each other. It is particularly important during this initial evaluation, that because all static judging is carried out at 5 metres, judges should avoid any close up evaluation of the models.
- b) The documentation requirements for F4H have been reduced to the minimum which is considered necessary to make a fair assessment of the judging aspects required. It is important that judges do not waste time seeking to assess any aspect which is not adequately supported by the documentation.
- c) The penalty marks as stated in ANNEX 6A paragraph 6A.1.9 will apply.
- d) Generally 15 minutes (approximately) is considered sufficient judging time for each model.
- e) When all the models have been individually judged, the spread of marks awarded, particularly the 'Complexity marks' for all the models should be reviewed by the panel of judges. The panel of judges have the right to alter the marks retrospectively if they subsequently believe them to be unfair. The relative mark of one model compared with the others is important and only when the Chief Judge agrees that this has been achieved should the scores be released for publication.

**6F.2 Scale Accuracy (Outline)**

The three view drawings together with the photographs are to be used to assess scale accuracy. Paragraph 6A.1.10.1 provides further advice on assessing scale accuracy.

**6F.3 Originality of Model Design & Construction**

- a) The judge must examine the Competitors Declaration including any supporting evidence presented by the competitor and if necessary question the competitor, in order to evaluate the extent to which the competitor has contributed to the Scale Accuracy (Outline Accuracy). A maximum of 10 marks should only be awarded to a model which is entirely 'scratch built' and declared as such by the competitor. The score must be reduced if the Scale Accuracy is achieved by someone other than the competitor, or by the use of commercially available machined, moulded or pre-cut parts. However an allowance should be made if the competitor is able to provide evidence that he has modified such parts to improve Scale Accuracy. A model which has been assembled 'straight out of the box' should score a zero.
- b) The following should be used as a guide:
 

i)	Competitor designed and built	10 points
ii)	Scratch Built from commercial plans	8 points
iii)	Built from a traditional kit	6 points
iv)	Built from substantially pre-made parts	4 points
v)	Modified ARTF	2 points
vi)	Unmodified ARTF	0 points

Depending on the declaration regarding self-made and modified parts, intermediate points may be awarded at the discretion of the static judges.

**6F.4 Colour and Markings Accuracy**

- a) Colour accuracy is determined by comparison of the model with the documentation which is presented. The ambient light conditions (e.g. light and shade) prevailing during judging may not be the same as that which applies to the documentation and particular consideration should be given when this occurs. Camouflage colour schemes should show the correct pattern and the correct degree of merging of the shades. Paragraph 6A.1.10.2 provides further advice on assessing colour.
- b) Check the colour, position and size of all markings, insignia, numbers and lettering. Judges should not make assumptions that markings are the same on each side of the model and should only award high marks when all the markings are fully supported by the documentation. Paragraph 6A.1.10.3 provides further advice on assessing markings.

**6F.5 Colour and Markings Complexity**

- a) Consideration should be given to the effort involved in reproducing the colour and markings of the prototype. This should not be confined to the number of colours and the extent of the markings, but also how they are distributed on the model. i.e. the complexity of the boundary

between colours and whether applied to a flat or curved surface, on fabric or solid surfaces etc.

- b) It is important to ensure that the marks awarded are a fair comparison with the spread of marks awarded across the range of models entered. Paragraphs 6A.1.10.2 and 6A.1.10.3 provide additional guidance on assessing Colour and Markings Complexity.

#### **6F.6 Realism**

Judges should consider how well the model captures the character of the full size aircraft as portrayed in the photographic documentation. If the subject aircraft is 'factory fresh' or an unblemished museum example, then the model should be in a similar pristine condition. Alternatively if the photograph of the subject aircraft shows worn or stained surfaces and weathered paintwork, then this should be reflected in the model. Judges should be careful to avoid penalising the omission of details which are not clearly visible at 5 metres.

**6.4 - CLASS F4A - FREE FLIGHT OUTDOOR SCALE AEROPLANES (PROVISIONAL)**

**6.4.1. General Characteristics**

- Maximum surface area ..... 150 dm<sup>2</sup>
- Maximum weight of complete model aircraft without fuel ..... 5 kg (≈50 Newton)
- Maximum loading..... 50g/dm<sup>2</sup>
- Motive Power:
  - (a) Piston engines, total..... 10 cm<sup>3</sup> max
  - (b) Electric Motors ..... no limitations
  - (c) Solid fuel reaction engines (Jetex)..... allowed

**6.4.2 Definition of an Official Flight**

An official flight shall be recorded when the model aircraft has been airborne for 30 seconds except when the wind velocity exceeds 4 m/s when the qualifying time shall be reduced to 20 seconds.

**6.4.3 Number of Flights**

Each competitor shall have the opportunity to make a minimum of four flights.

**6.4.4 Flying Time**

Competitors must be called at least five minutes before they are required to occupy the starting area. Each competitor shall have a flying time of five minutes (plus one minute for each additional engine of multi-engined model aircraft) to complete each flight programme, the flying time commencing when the competitor begins to start the engine(s) or two minutes after entering the starting area, whichever is first. No points may be scored after the end of the flying time.

**6.4.5 Flight**

- (a) Take-Off (Optional, see 6.1.6 (a) ..... K= 13
- (b) Initial Climb..... K= 10
- (c) Realism in Flight..... K= 23
- (d) Transition to descent..... K= 6
- (e) Descent and landing approach ..... K= 13
- Total K Factor ..... K= 65

**6.4.6 Complexity Bonus**

The flight score shall be subject to a complexity bonus as listed in the following schedule. All bonuses are additive. The best flight score shall be factored by the appropriate total bonus, to become the scoring flight.

- Engines (on different thrust lines)..... Bonus
  - Single ..... 0
  - Twin..... 10%
  - Three..... 10%
  - Four ..... 20%

N.B. To qualify for the multi engine bonus each propeller must be driven by a separate engine unless this was not the case with the prototype modelled. The engines must deliver similar levels of power.

- Undercarriage ..... Bonus
  - Fixed (any configuration) ..... 0
  - Retractable (remains up for landing)..... 5%
  - Retractable (lowers again for landing) ..... 10%

**6.4.7 Marking (Flight Points)**

Each part of the flight<sub>3</sub> as defined in 6.4.5. will be awarded marks between 0 and 10 by each judge during the flight. These marks are then each multiplied by the appropriate K factor and aggregated before the bonuses are applied as described in 6.4.6.

**6.4.8 Flight Score**

The flight score shall be the aggregate sum of points awarded by the judges as described in 6.4.7.

**6.4.9 Total Score**

Add the points earned in 6.1.11 to the best flight score as defined in 6.4.8.

Note: Static judging is to take place at a minimum distance of 2 metres for items 1 to 5 in 6.1.11. and 0.5 metre for items 6 to 8 in 6.1.11.

**6.5 CLASS F4E - FREE FLIGHT INDOOR CO<sub>2</sub> OR ELECTRIC SCALE AEROPLANES (PROVISIONAL)**

**6.5.1. General Rules and Standards for Static Judging**

As 6.1. with the following exception:

- a) 6.1.10. Minimum judging distances to read 1,5 m and 0,5 m.  
Note: 6.1.6a shall also apply.

**6.5.2. General Characteristics**

Maximum flying weight: ..... 150 g  
 Maximum wing loading: ..... 15 g/dm<sup>2</sup>  
 Motive power:

- a) Commercially produced reciprocating engines driven by carbon dioxide gas with the gas storage tank carried on the model aircraft, or
- b) Electric motors with the batteries carried in the model aircraft.

**6.5.3. Definition of an Official Flight:** An official flight shall be recorded when the model aircraft has been airborne for 15 seconds.

**6.5.4. Number of Flights:** Each competitor shall have the opportunity to make a minimum of four flights.

**6.5.5. Flying Time:** A minimum period of 15 minutes shall be allocated for trimming before the competition begins, and the competitor must be called 5 minutes before he/she is required to occupy the starting area. Failure to comply will result in loss of the flight. The model aircraft will be released upon instruction from the flight judges within a period of 3 minutes, plus 1 minute for each additional motor. Only one release is permitted during the allocated time.

**6.5.6. Judging for Flight Realism**

- 6.5.6.1 Take-off (optional see Section 4c, 6.1.6a) ..... K = 10
- 6.5.6.2. Initial climb ..... K = 8
- 6.5.6.3 Descent and landing approach ..... K = 12
- 6.5.6.4 Quality of landing ..... K = 11
- 6.5.6.5. Realism in flight..... K = 24
- Total K Factor. .... K = 65

**6.5.7. Complexity Bonus:** The flight shall be subject to a complexity bonus as listed in the following schedule. All bonuses are additive. The best flight score shall be factored by the appropriate total bonus to become the scoring flight.

- a) Engines (motors) (on different thrust lines)     bonus
- Single ..... 0
- Two ..... 10%
- Three ..... 10%
- Four ..... 20%

Note: To qualify for the multi-engine (motor) bonus, each propeller must be driven by a separate engine (motor) unless this was not the case with the prototype modelled. The engines (motors) must deliver similar levels of power.

- b) Landing ..... bonus
- Fixed (any configuration) ..... 0
- Retractable (remains up for landing)... ..... 10%
- Retractable (lowers again for landing)..... 20%

**6.5.8. Marking (Flight Points):** Each part of the flight, as defined in 6.5.6. will be awarded marks between 0 and 10 by each judge during the flight. These marks are then each multiplied by the appropriate K-factor and aggregated before the bonuses are applied as described in 6.5.7.

**6.5.9. Flight Score:** The flight score shall be the aggregate sum of points awarded by the judges as described in 6.5.6. and 6.5.7.

**6.5.10. Total Score:** Add the points earned in 6.1.11. to the best flight score as defined in 6. 5.9.

**PAGE DELIBERATELY LEFT BLANK**



**6.6 CLASS F4D - FREE FLIGHT INDOOR RUBBER SCALE AEROPLANES (PROVISIONAL)**

**6.6.1. General Rules and Standards for Static Judging**

As 6.1. with the following exception:

- a) 6.1.10. Minimum judging distances to read 1,5 m and 0,5 m.

Note: 6.1.6a shall also apply.

**6.6.2. General Characteristics**

Maximum flying weight: ..... 150 g

Maximum wing loading: ..... 15 g/dm<sup>2</sup>

Motive power: Extensible motor(s) only

**6.6.3. Definition of an Official Flight**

An official flight shall be recorded when the model aircraft has been airborne for 15 seconds.

**6.6.4. Number of Flights**

Each competitor shall have the opportunity to make a minimum of four flights.

**6.6.5. Flying Time**

A minimum period of 15 minutes shall be allocated for trimming before the competition begins, and the competitor must be called 5 minutes before she/he is required to occupy the starting area. Failure to comply will result in loss of the flight. The model aircraft will be released upon instruction from the flight judges within a period of 3 minutes, plus 1 minute for each additional motor. Only one release is permitted during the allocated time.

**6.6.6. Judging for Flight Realism**

6.6.6.1. Take-off (optional, see Section 4c, 6.1.6a) .....K = 10

6.6.6.2. Initial climb.....K = 8

6.6.6.3. Descent and landing approach .....K = 12

6.6.6.4. . Quality of landing.....K = 11

6.6.6.5. Realism of flight.....K = 24

Total K Factor.. .....K = 65

**6.6.7. Complexity Bonus**

The flight shall be subject to a complexity bonus as listed in the following schedule. All bonuses are additive. The best flight score shall be factored by the appropriate total bonus to become the scoring flight.

a) <u>Motors</u> (on different thrust lines)	bonus
Single	0
Twin	10%
Three	10%
Four	20%

Note: To qualify for the multi-engine bonus, each propeller must be driven by a separate engine unless this was not the case with the prototype modelled. The engines must deliver similar levels of power.

b) <u>Landing gear</u>	bonus
Fixed (any configuration).....	0
Retractable (remains up for landing).....	10%
Retractable (lowers again for landing)...	20%

**6.6.8. Marking (Flight Points)**

Each part of the flight, as defined in 6.6.6. will be awarded marks between 0 and 10 by each judge during the flight. These marks are then each multiplied by the appropriate K-factor and aggregated before the bonuses are applied as described in 6.6.7.

**6.6.9. Flight Score**

The flight score shall be the aggregate sum of points awarded by the judges as described in 6.6.6. and 6.6.7.

**6.6.10. Total Score**

Add the points earned in 6.1.11. to the best flight score as defined in 6.6.9.

**PAGE DELIBERATELY LEFT BLANK**

**6.7 CLASS F4F - FREE FLIGHT PEANUT SCALE AEROPLANES (PROVISIONAL)**

**6.7.1. General Rules**

Only the following rules from 6.1 will apply:

- a) 6.1.7. Number of models
- b) 6.1.9.2. Name of entry

**6.7.2. Definition of Peanut Formula Scale Models**

A Peanut Formula scale model aircraft shall be a reproduction of a heavier-than-air man carrying aircraft.

**6.7.3. General Characteristics:**

Maximum dimensions:

- 33 cm span or
- 23 cm overall length excluding the propeller.

Motive power: Extensible motor(s) only.

**6.7.4. Documentation**

The minimum documentation is to be one of the following:

- a) A general arrangement drawing of at least two inches (5 cm) wingspan, plus one photograph or printed reproduction of the prototype. If the photograph or printed reproduction is not in colour, then an authentic written colour description must be included; or
- b) a coloured three-view ( eg “Profile” publication) to a minimum of 1/144 scale. The competitor must also state in the documentation, the type of covering material used.

**6.7.5. Flying Section**

Each competitor is allowed up to 9 official flights. An official flight is counted each time the model aircraft is released for a declared flight. The times of the longest two flights (each rounded down to the nearest second) will be aggregated to form the competitor’s flight score. Flights may be hand launched or from take-off. If take-off is successfully achieved, without pushing or similar assistance, then 10 seconds will be added to that flight time recorded.

**6.7.6. Appearance Score**

Models will be judged visually, in comparison with the documentation provided, by one or more judges. No measurements will be taken. Marks will be awarded as follows:

- a) Workmanship ..... 0 - 15
- b) Complexity and accuracy of colour and markings 0 - 10
- c) Authentic details:..... 0 - 5
- d) Flying surfaces:
  - All double surface..... 4
  - Double surface wing but single surface tail..... 2
  - Single surface..... 0

Note: If however the prototype itself was single surface, then the model aircraft should be likewise single surface and be awarded the full 4 points.
- e) Surface Finish:
  - Authentic colour 5 - 9
  - Unpainted colour tissue 4
  - Unpainted condenser paper 3
  - Clear Microfilm 0
- f) Landing gear:
  - Scale length . 3
  - Slightly enlarged 2
  - Greatly enlarged or no documentation 1
  - None or retracted 0

cont/...

g) Dihedral:	
Scale	3
Slightly exaggerated	1
Grossly exaggerated or no documentation.	0
h) Stabiliser outline:	
Correct size and shape	3
Correct size, wrong outline	2
Enlarged	1
Grossly enlarged	0
i) Bonus Points for complexity:	
Low wing	9
Biplane	9
Triplane	15
Autogyro.	21
Helicopter	27
Flying boat or floatplane	2 per wing
Scale number of tailplane ribs	1
Scale number of rudder ribs..	1/2
Separate ailerons	1
Separate rudder	1/2
Separate elevator or all-moving tailplane	1/2
Other than square fuselage	1
Wheel spats or pants	1
Three dimensional pilot	1
Exposed engine	1
j) Negative points for deviation from scale to assist flying performance:	
Lengthening of nose or tail moment	2 each
Moving wing back	2
Simplifying fuselage cross-section	2
Enlarging rudder	2
All other non-scale performance aids	2 each

The competitor's appearance score for his model aircraft will be the sum of the marks awarded in 6.7.6.(a) through 6.7.6.(j).

### 6.7.7 Scoring

The order of marking in 6.7.5. and 6.7.6. will produce a "place" in the Flying and Appearance sections respectively. Each competitor's numerical "places" in the two sections are added. The lowest overall totals then determine the final overall placings in the competition. A fly-off in which the realism of flight is the determining factor (marked to section 6.4.5.) will be held, if necessary, to break ties in the final placing of the leaders. In the event of a tie, places shall be decided by referring to the Appearance score, followed if necessary by reference to the flight scores, comparing first flights, then the second flights. If there is still a tie, then places will be decided by a duration fly-off.

**6.8. CLASS F4G - RADIO CONTROLLED LARGE SCALE AEROPLANES (PROVISIONAL)**

**6.8.1. General Rules**

As 6.1. with the following addition:

Maximum weight excluding fuel: 20 kg

Note: The maximum take-off weight including fuel: 25 kg still applies, ref Volume *CIAM General Rules* B.1.3. and may be checked at random.

**PAGE DELIBERATELY LEFT BLANK**

**6.10. CLASS F4J - RADIO CONTROLLED TEAM SCALE AEROPLANES (PROVISIONAL)**

**The rules for F4J are the same as those for F4C except for the variations as shown.**

- 6.10.1. See 6.3.1.
- 6.10.2. A F4J team shall consist of one pilot and one designated builder with their Sporting licenses issued by the same NAC. The pilot can only be the pilot for one builder.
- 6.10.3. See 6.1.9.
- 6.10.4. See Annex 6E but the Declaration Form must be signed by both the pilot and the builder.
- 6.10.5. See 6A.1.
- 6.10.6. See 6C.1.

## **6.11. CLASS F4K - RADIO CONTROLLED SCALE HELICOPTERS (PROVISIONAL)**

*Note: New class in 2015*

### **6.11.1. General Characteristics**

This is a rotary wings motorised scale model class.

The requirement for the competitor to have constructed his own model in F4K (rule 6.1.9.4.e) only applies to the fuselage and the main and tail rotors, not to the mechanical components, but he must have completed the assembly of all the mechanical components in the model.

See also 6.1.10 (Judging for Fidelity to Scale and Craftsmanship) and 6.1.11. (Static Scoring).

The maximum weight of the complete model aircraft with fuel, in flying condition, including any dummy pilot is 23 kg ( $\approx 230$  Newton).

Model aircraft using electric motors as a power source shall be weighed without batteries used for those motors.

The scale model weight must be taken at the helipad just before take-off.

Note: For all other scale model specifications, see Volume *CIAM General Rules* B.1.3.

### **6.11.2. Noise**

See 6.3.2

### **6.11.3. Documentation**

See 6.1.9.

### **6.11.4. Official Flights**

- a) Each competitor will be called to fly three rounds, and must execute an official flight within the required time limit on each occasion to be eligible for flight points for that flight. In the case of two flightlines (see 6.1.4), each competitor will fly four rounds, two in front of each panel of judges and two on each flight line and the lower score from each panel will be deleted.
- b) If a competitor is unable to start or complete a flight and, in the opinion of the Contest/Flightline Director, the cause is outside the control of the competitor, the Contest/Flightline Director may, at his discretion, award the competitor a reflight. The Contest Director shall decide when the reflight shall take place.
- c) An official flight is considered to have commenced at whichever of the following is first:
  - i) The competitor signals to the timekeeper that he is commencing to start his engine(s).
  - ii) Three minutes after the competitor is instructed to start his flight.
- c) An official flight is terminated when the model aircraft lands and stops.

### **6.11.5. Flying Time**

- a) A competitor will be advised that he will be required to start his flight not less than 5 minutes before the instruction to start.
- b) The competitor will then be instructed to start his flight.
- c) Timing of the flight will commence when the official flight commences (see 6.3.3.c.).
- d) The competitor will be allowed 10 minutes to complete his flight.
- f) No points will be awarded for any manoeuvre that is not completed at the end of the time allowed.

### **6.11.6. Starting Time**

- a) If the model aircraft is not airborne within 5 minutes, after the official flight and timing commences, the official flight will end and no points will be awarded for the flight.
- b) If the engine(s) stops after the take-off has commenced, but before the model aircraft starts the second manoeuvre (the first one is the take-off), the engine(s) may be restarted.
- c) There is only one attempt allowed to repeat the whole procedure. In the case of a repeated attempt, no points will be assigned for the interrupted manoeuvre.

Note: In this case rule 6.12.5(a) still applies

*cont/...*



**6.11.7. Flight**

6.3.6.1. Take-off .....	K =14
6.3.6.2. Option 1 .....	K =10
6.3.6.3. Option 2 .....	K =10
6.3.6.4. Option 3 .....	K =10
6.3.6.5. Option 4 .....	K =10
6.3.6.6. Option 5 .....	K =10
6.3.6.10. Approach and Landing .....	K =14
6.3.6.11. Realism in flight	
a) Flight Presentation .....	K =4
b) Speed of the model aircraft .....	K =9
c) Smoothness of flight.....	K =9
Total K Factor .....	K =100

Notes: The flight schedule must include the two manoeuvres: (i) 10 (ten) second hover with clearing turns (take off) and (ii) 45° climb out to a minimum of 8 (eight) metres, to be accepted as complete.

The scale of the model aircraft and the cruising or maximum speed of the prototype must be stated on the example Flight Score Sheet (Annex 6E.2.)

Only one attempt is permitted for each manoeuvre. The only exception is the procedure of getting a model aircraft airborne, as defined in 6.3.5.b.

**6.11.8 Optional Demonstrations**

The two manoeuvres, 10(ten) second hover clearing turns ( take off) and 45° climb out at a minimum of 8 metres are mandatory manoeuvres to be included in each flight and positioned in the flight schedule at the competitor's discretion.

Competitors must be prepared, if required by the judges, to give evidence that the options selected are typical and within the normal capabilities of the aircraft subject type modelled.

Only one manoeuvre involving the demonstration of a mechanical function may be included in a competitor's choice of options.

Selection must be indicated on the score sheet and given to judges before commencing the flight.

The options may be flown in any order.

The order in which all manoeuvres are to be flown must be marked on the score sheet and any manoeuvre flown out of order will be marked zero.

A Chandelle.....	K = 10
B Flight in a straight line at constant height.....	K = 10
C Figure Eight.....	K = 10
D Side flight to left or right .....	K = 10
E Flight in triangular circuit.....	K = 10
F Flight in rectangular circuit .....	K = 10
G 180° Ascending turn.....	K = 10
H 360° Descending circle.....	K = 10
I Lazy Eight .....	K = 10
J 90° Procedure to the right and 180° Circle.....	K = 10
K One loop .....	K = 10
L Inverted flight.....	K = 10
M Figure Backward.....	K = 10

**6.11.9 Marking (flight points)**

See 6.3.8

**6.11.10 Flight Score**

See 6.3.9

*cont/...*

**6.11.11 Final Scoring**

See 6.3.10

**6.11.12 Safety**

- a) All manoeuvres must be performed parallel with the judges' line such that if any part of the manoeuvre is performed behind the judges' line it will score ZERO.
- b) These manoeuvres have the right to be performed into wind as long as they do not overfly a designated area behind the judges' line laid out for the protection of spectators, officials and other competitors or helpers.
- c) If a model aircraft is in the opinion of the Chief Judge or Flightline Director unsafe, or being flown in an unsafe manner, he may instruct the pilot to land.

**6.11.13 F4K Contest Area Layout**

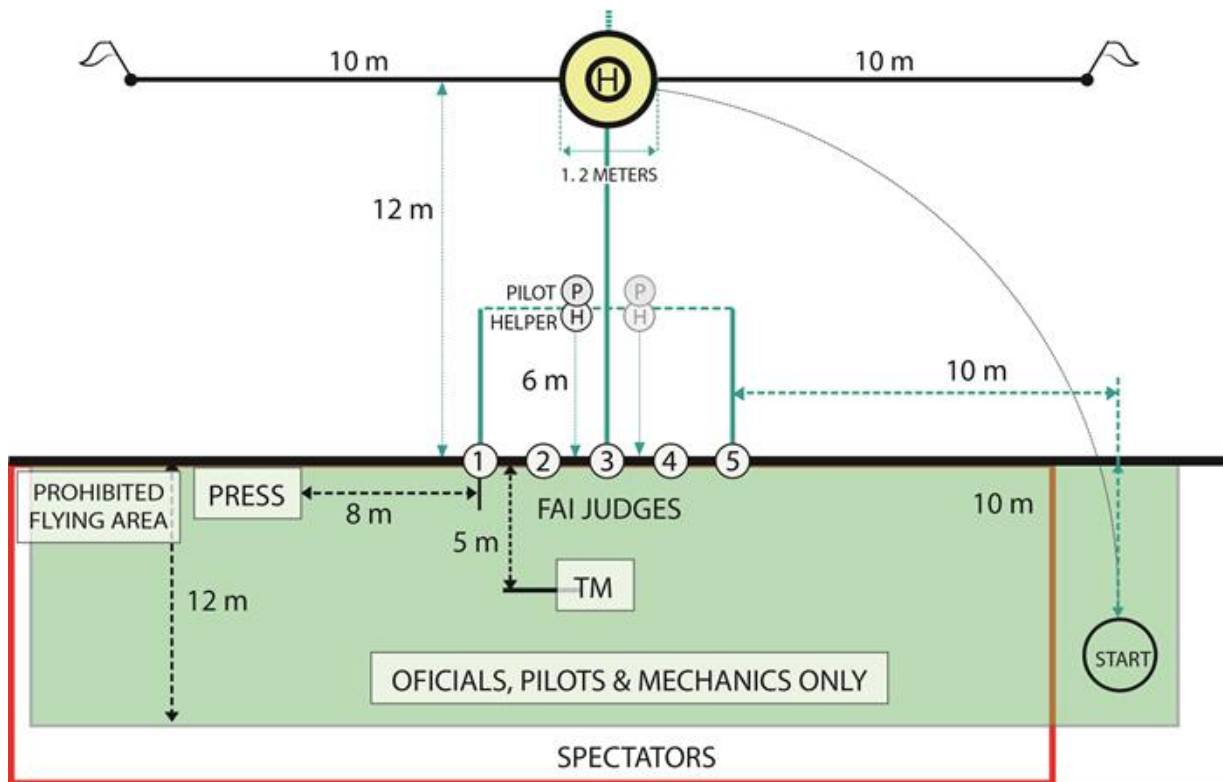

**F4K Contest Area Layout**

## ANNEX 6G

### F4K – JUDGES' GUIDE

#### 6G.1 Static Judging

See Annex 6A – Class F4 Judges' Guide for Static Judging with the following exclusion : Main and tail rotor systems are not assessed (because of technical demands and safety) except for the number of rotor blades and direction of rotation.

#### 6G.2 Flight Judging

##### 6G.2.1 Realism in Flight

See 6C.3.6.11

##### 6G.2.2 Mandatory Manœuvres

**A** Take off with 90° turn and 180° turn

**B** 45° Climb out

##### 6G.2.3 Landing Manœuvres

**NOTE:** The competitor may only choose one option in each round for landing.

**1** Translational Landing

**2** Run On Landing

**3** Autorotation Landing

##### 6G.2.4 Optional Manœuvres

**A** Chandelle

**B** Fly Past at **Constant Height**

**C** Figure Eight

**D** Sideways Flight

**E** Flight in Triangular Circuit

**F** Flight in Rectangular Circuit

**G** 180° Ascending Turn

**H** 360° Descending Turn

**I** Lazy Eight

**J** Procedure 90° with Straight Flight and 180° Angle

**K** One Loop

**L** Inverted Flight

**M** Figure Backward

**A TAKE OFF WITH 90° TURN AND 180° TURN (MANDATORY)**

To start the manoeuvre, take off smoothly from the centre of the helipad. The model must ascend vertically over the centre of the helipad until the skids or landing gear are at a height of two metres, with tail rotor facing the centre judge (Figure 1). Hold this position for a minimum of 10 seconds, followed by a 90° clearing turn to the left or right side. Hover in this position for 5 seconds followed by a 180° clearing turn in the opposite direction followed by a 5 second hover in this position. (See figures 2A and 2B)

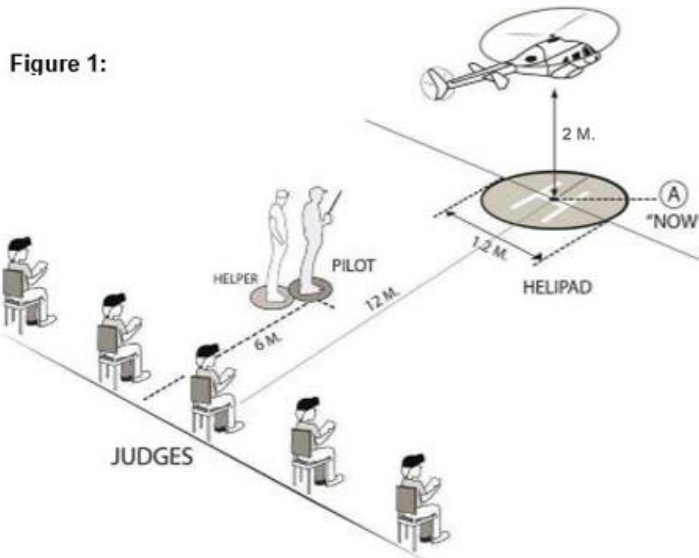
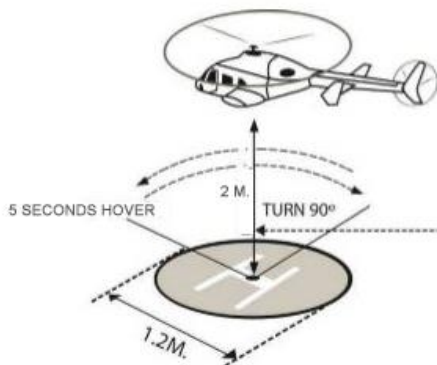
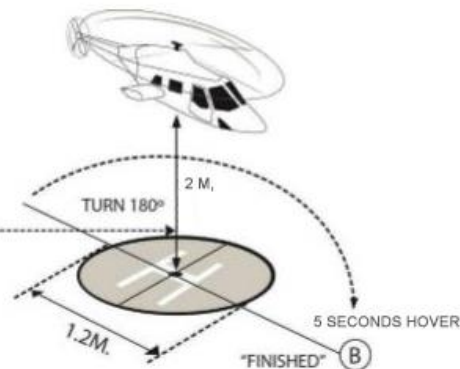
**Figure 2(A):****Figure 2(B):****ERRORS:**

1. Constant height of two metres not maintained.
2. Not centred on judge's position (Figure 1) or helipad centre (Figures 2A and 2B).
3. Too far away/too close/too high/too low over helipad centre.
4. Start and finish not centred on judges' position.
5. Climb up not smooth, continuous and steady.

**B 45° CLIMB OUT (MANDATORY)**

The manoeuvre starts at eye level (Point A) with a 45° climb out parallel to the flight line, finishing at point B. This figure can be made to left or right side.

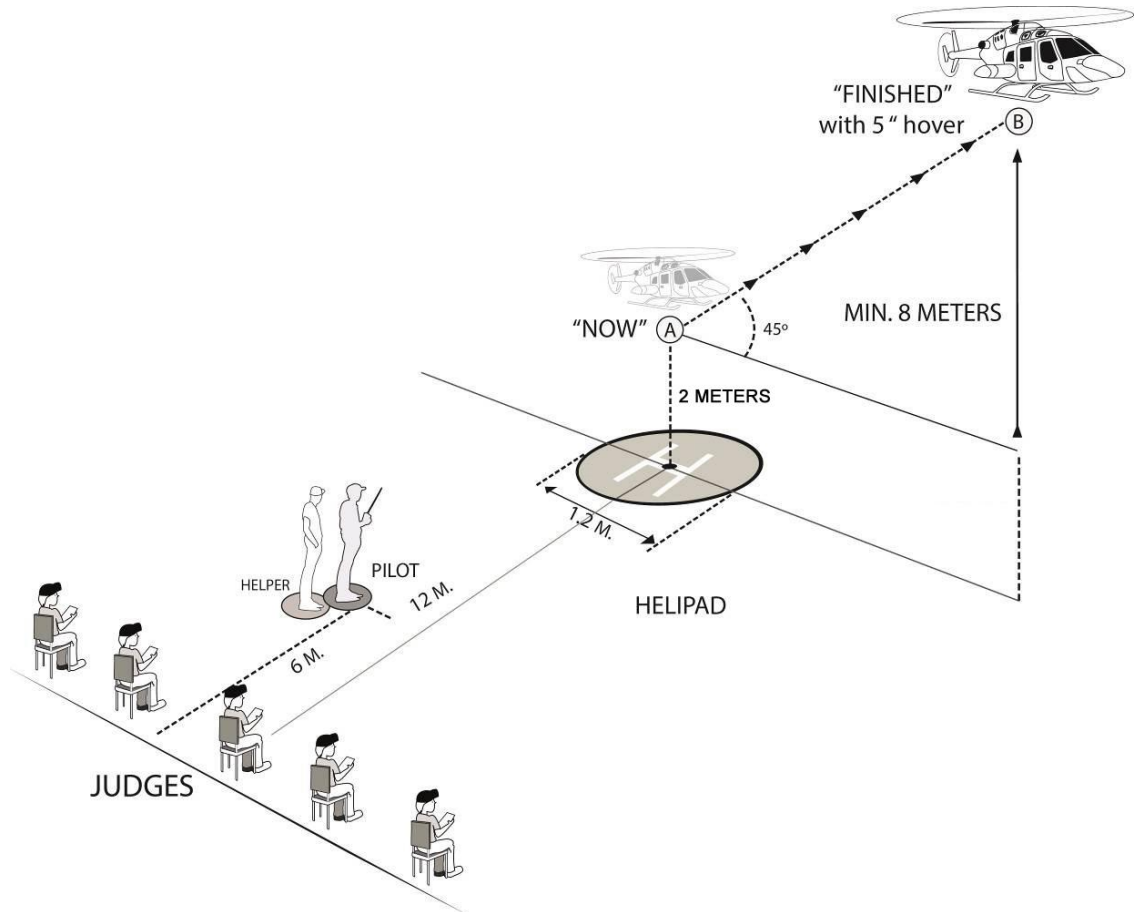
**ERRORS:**

1. Not starting at eye level.
2. Not finishing the manoeuvre at Point B (8 metres height).
3. Not keeping the climb out parallel to the flight line.
4. Climb out not smooth and at a continuous 45° angle.

### TRANSLATIONAL LANDING (OPTION 1)

At the point A, the helicopter will begin a translational straight-line descent with  $45^\circ$  to a soft final landing on the helipad.

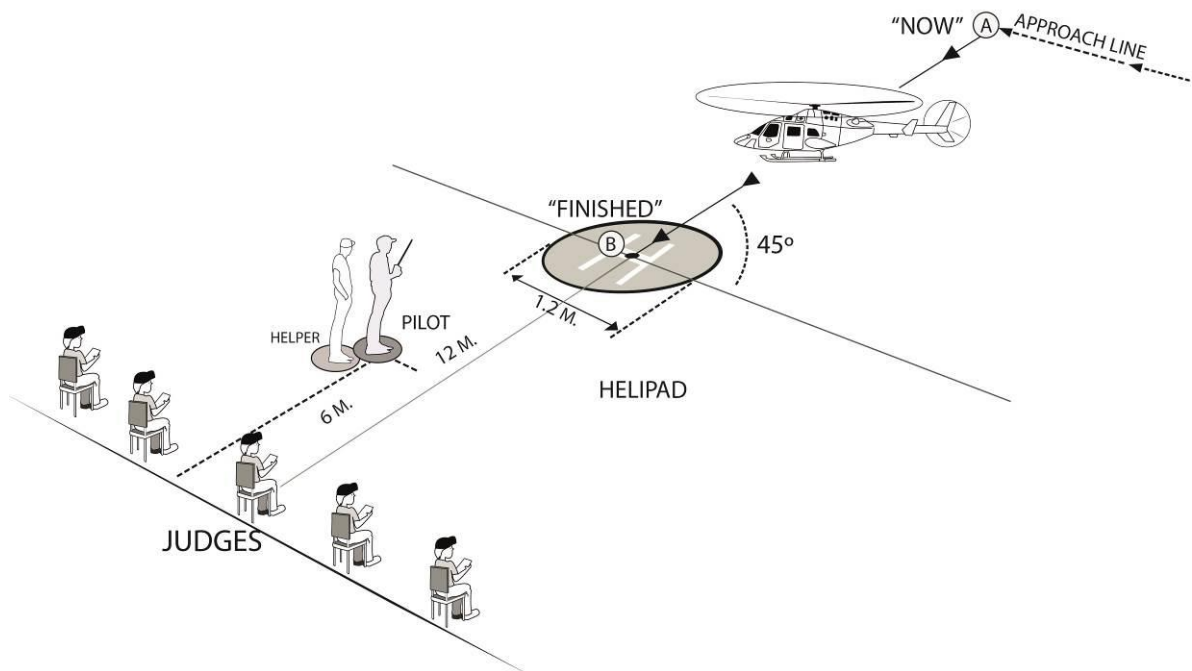

### ERRORS:

1. Insufficient climb achieved.
2. The angle of descent is not constant throughout manoeuvre.
3. Model aircraft not smooth and steady.
4. Too far away/too close/too high/too low.
5. Model not landing on helipad centre.
6. The descending angle is not  $45^\circ$ .

**RUN ON LANDING (OPTION 2)**

The model approaches parallel to the flight line, descending smoothly. The manoeuvre starts at point A, which has a minimum height of 8 metres. The model must touch down at a distance of between 3 to 5 metres from the helipad, sliding to a stop within the helipad. This manoeuvre can be made to the left or right side.

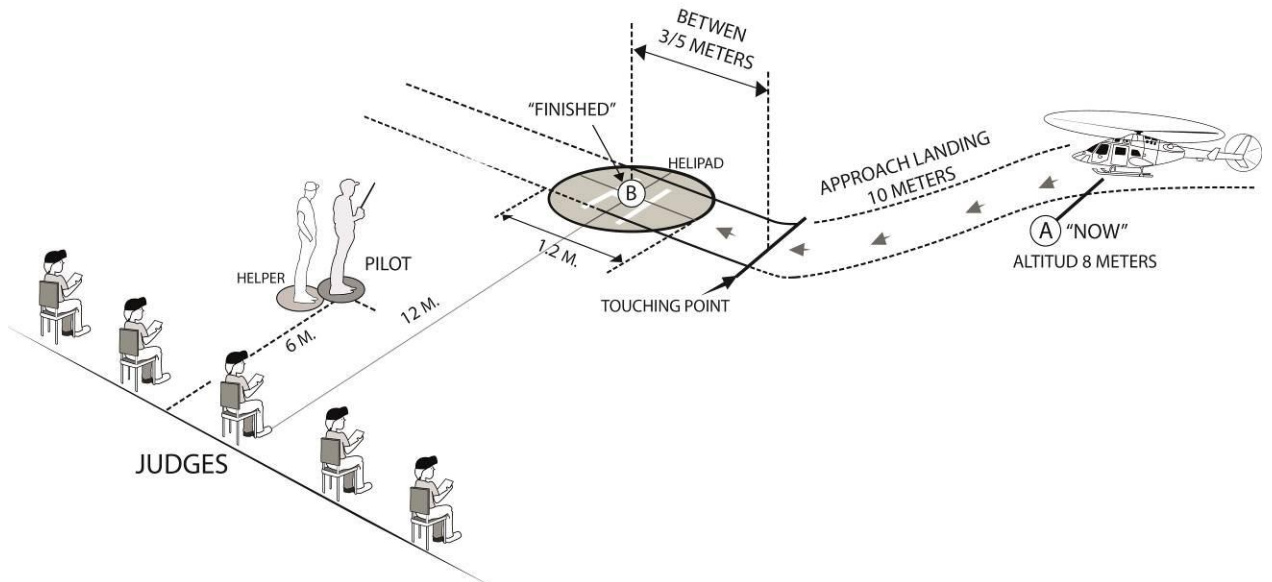
**ERRORS:**

1. Model descent not smooth and continuous.
2. Start and finish of manoeuvre not parallel with the flight line.
3. Run on slide is too short or too long.
4. Run on slide is not smooth.
5. Model does not stop within the helipad.
6. Model does not finish on helipad centre.

**AUTORROTATION LANDING (OPTION 3)**

The model enters the manoeuvre at a minimum height of 20 metres, descending at an angle that is between  $30^{\circ}$  and  $50^{\circ}$ , parallel to the flight line. The model must be in an autorotation state and the engine must be disengaged before the manoeuvre starts. The manoeuvre ends with the model landing safely within the helipad. This manoeuvre can be made from the left or right side.

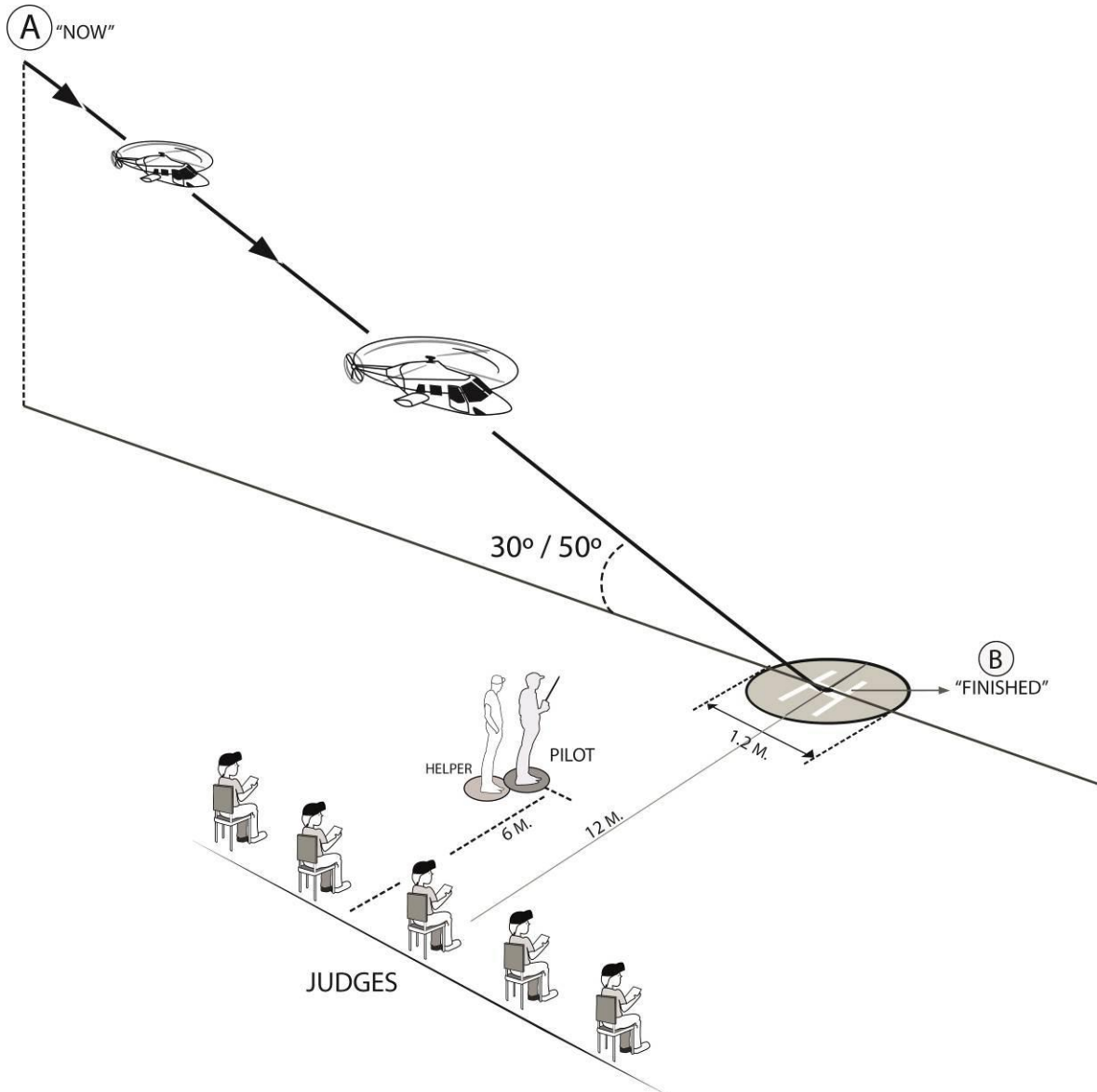
**ERRORS:**

1. The model bounces on touch down.
2. The model does not perform a smooth landing.
3. The model is not in a constant descent.
4. The model does not land within the helipad.
5. The engine was not stopped.
6. The model does not land parallel to the flight line.
7. The model does not land on the centre of the helipad.
8. The manoeuvre is too far away/ too close / too low / too high.
9. The main rotor edge is out of the helipad circle.

**NOTE:** The competitor may only choose one option in each round for landing.



## A CHANDELLE

From a straight and level flight at eye level, the model aircraft passes the judges and then performs a 180° climbing turn in a direction away from the judges, resuming straight and level flight on the opposite heading. The rate of climb should be commensurate with that of the prototype.

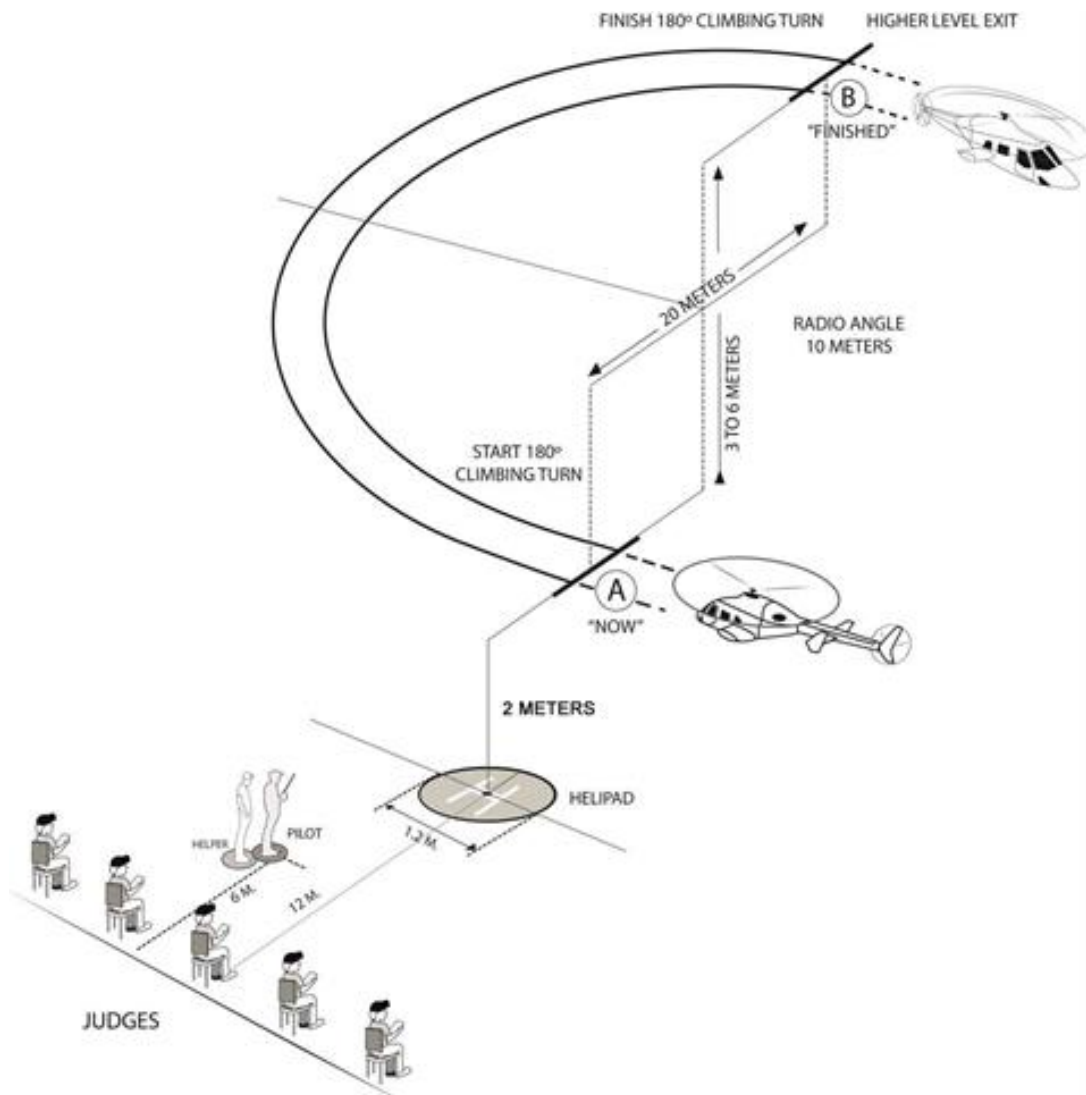

### ERRORS:

1. Turn not smooth and continuous.
2. Climb not smooth and continuous.
3. Half height gain not at 90° position.
4. Excessive/unrealistic engine power used to achieve the climb.
5. Insignificant height gain.
6. Start and finish not centred on judges' position.
7. Entry and exit paths not parallel with the judges' line.
8. Final track not 180° opposite to entry.
9. Entry and exit not in straight and level flight.
10. Too far away or too high.

**B FLY PAST AT CONSTANT HEIGHT**

Model aircraft approaches in straight flight at a constant height not exceeding 2 metres for a minimum distance of 20 metres. This is in effect a low fly-past. The manoeuvre can be done to the left side or to the right side.

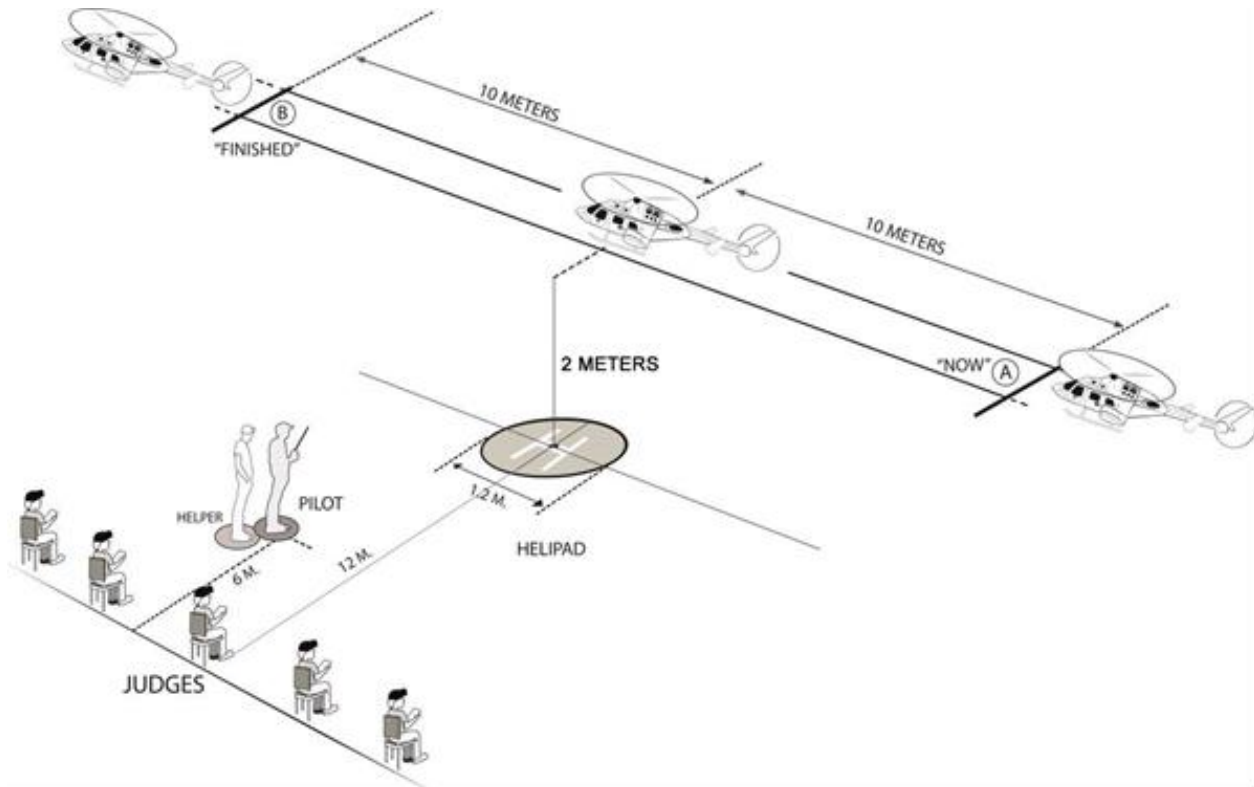
**ERRORS:**

1. Not a straight course (slight corrections acceptable with light aircraft).
2. Not at a constant height.
3. Not 2 metres or below.
4. Not passing over the landing area.
5. No centred on the judges' position.
6. Not parallel with the judges' line.
7. The distance is too short (too long is not an error).
8. The model aircraft's flight is not steady.
9. Model is too far away / too close / too low.

**C FIGURE EIGHT**

The model aircraft approaches in straight and level flight on a line parallel with the judges' line, and then a one-quarter circle turn is made in a direction away from the judges' line. This is followed by a 360° turn in the opposite direction, followed by a 270° turn in the first direction, completing the manoeuvre on the original approach line. The intersection of the manoeuvre shall be on a line that is at right angles to the direction of entry and passes through the centre of the judges' line.

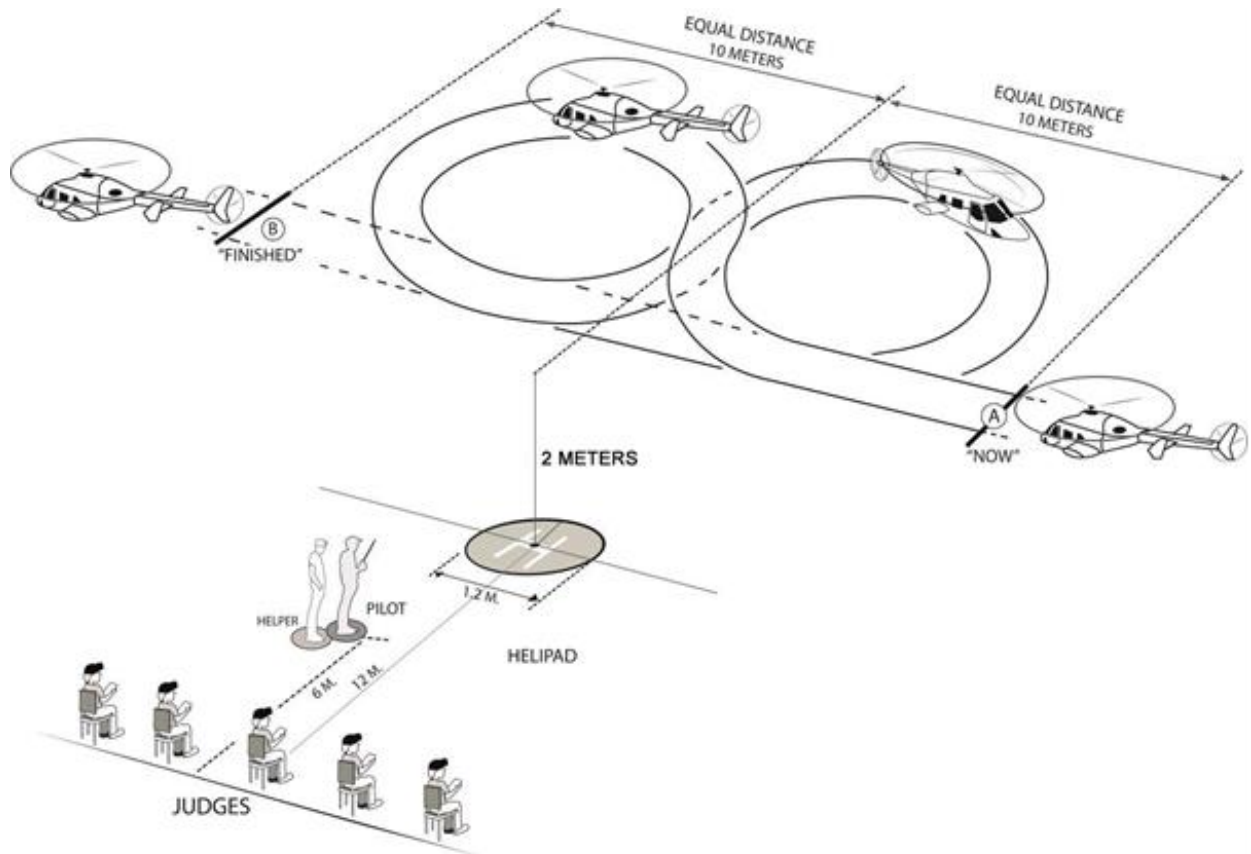
**ERRORS:**

1. Entry into first circle is not at right angles to original flight path.
2. Circles are unequal size.
3. Circles are misshapen.
4. Constant height is not maintained.
5. Intersection is not centred on judges' position.
6. Entry and exit paths are not on the same line.
7. Entry and exit paths are not parallel with the judges' line.
8. Overall size of manoeuvre is not realistic for prototype.
9. The model aircraft's flight path is not smooth and steady.
10. The model is too close/too high/too low/ too far.

## D SIDWAYS FLIGHT

The model aircraft approaches in straight flight at a constant height not exceeding eye level, parallel to the judges' line.

At Point A, start the manoeuvre with the nose of the model aircraft facing opposite to the judges' position and retain this orientation during the rest of the manoeuvre to the end. Maintain the height to the end of the manoeuvre. This is a low side fly past. This manoeuvre can be done from the right side or from the left side.

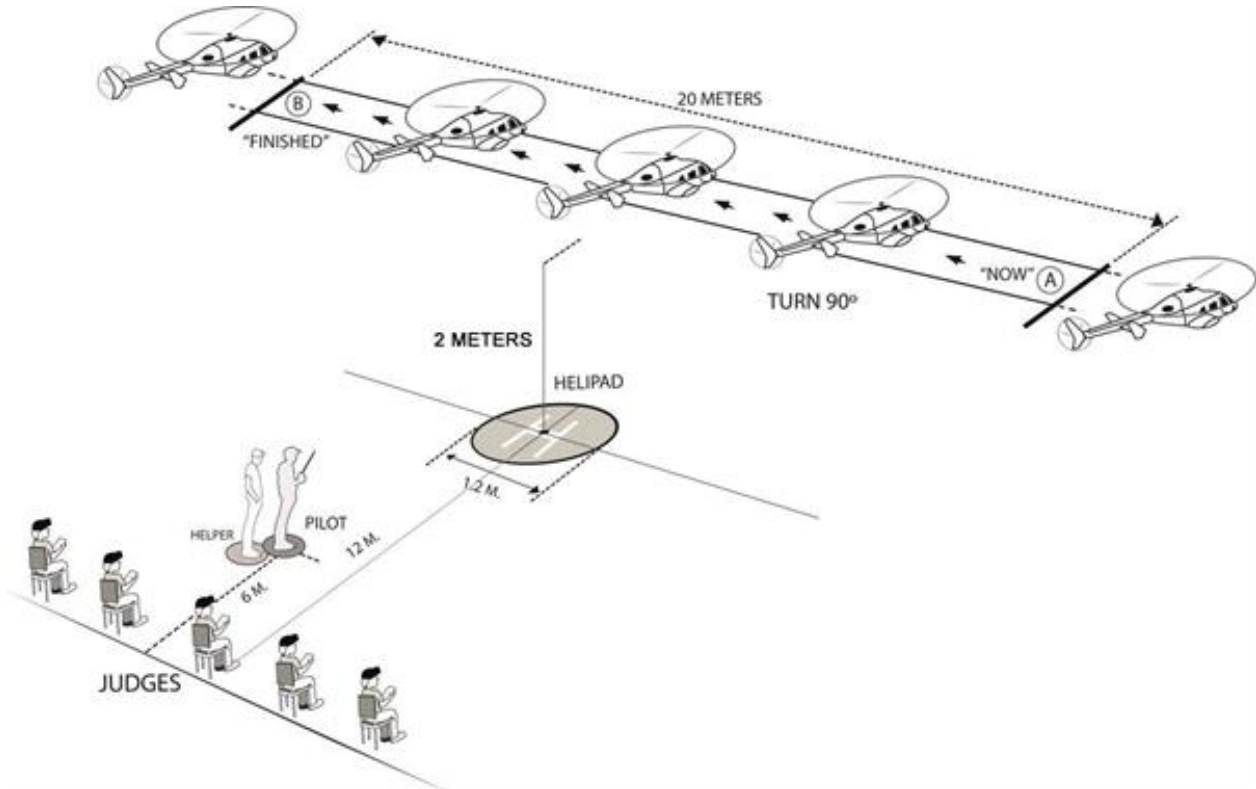

### ERRORS:

1. Model is too far away / too close / too high / too low.
2. Model is not at constant height.
3. Height exceeds 2 metres.
4. The nose of the model aircraft is not facing opposite (90°) to the judges' position.
5. The manoeuvre is not steady.

## E FLIGHT IN TRIANGULAR CIRCUIT

The model aircraft approaches in a straight and level flight at a maximum height of 2 metres to a point directly in front of the judges, then turns away to track  $60^\circ$  away from the judges' line, flies straight and level for a minimum of 20 metres, turns to track parallel with the judges' line, flies a further minimum of 20 metres, then turns to track towards the judges and flies a further minimum of 20 metres to a position above the centre of the landing area, which completes an equilateral triangle (a triangle with sides of equal length and included angles of  $60^\circ$ ), before making a final turn to intercept the original entry track.

Angles of  $60^\circ$  have been marked on the diagram below.

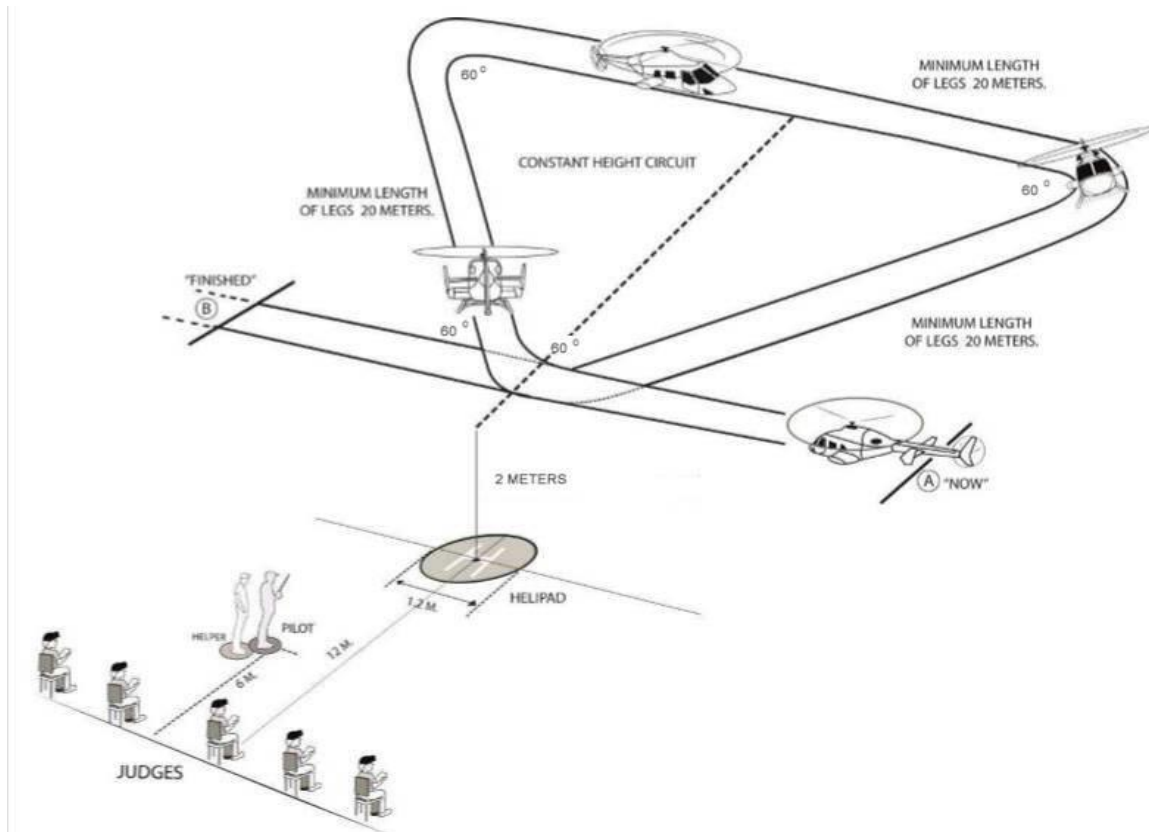

### ERRORS:

1. Manoeuvre is not commenced and finished at points equidistant from the judges.
2. Model aircraft changes height.
3. Rate of turn at corners not constant or inside corners of triangle not  $60^\circ$ .
4. Sides of the triangle are not straight.
5. Sides of triangle are not equal lengths.
6. Sides of the triangle are too long or too short.
7. Apex of the triangle is not centred on judges' position.
8. Correction for drift not properly made.
9. Start and finish tracks are not the same.
10. Start and finish tracks are not parallel with the judges' line.
11. Model is too far away / too close / too high / too low.
12. Manoeuvre is not constant and smooth.

## F FLIGHT IN RECTANGULAR CIRCUIT

The model aircraft approaches in straight level flight at a maximum height of 2 metres to a point directly in front of the judges, then continues for a minimum of 10 metres before it turns away to track 90° from the judges' line and flies straight and level for a minimum of 20 metres before turning to track parallel with the judges' line for a further minimum of 10 metres, turns to track directly towards the judges for a minimum of 20 metres, to a point in front of the judges, before completing a final turn to intercept the original entry track. This manoeuvre describes a rectangle over the ground.

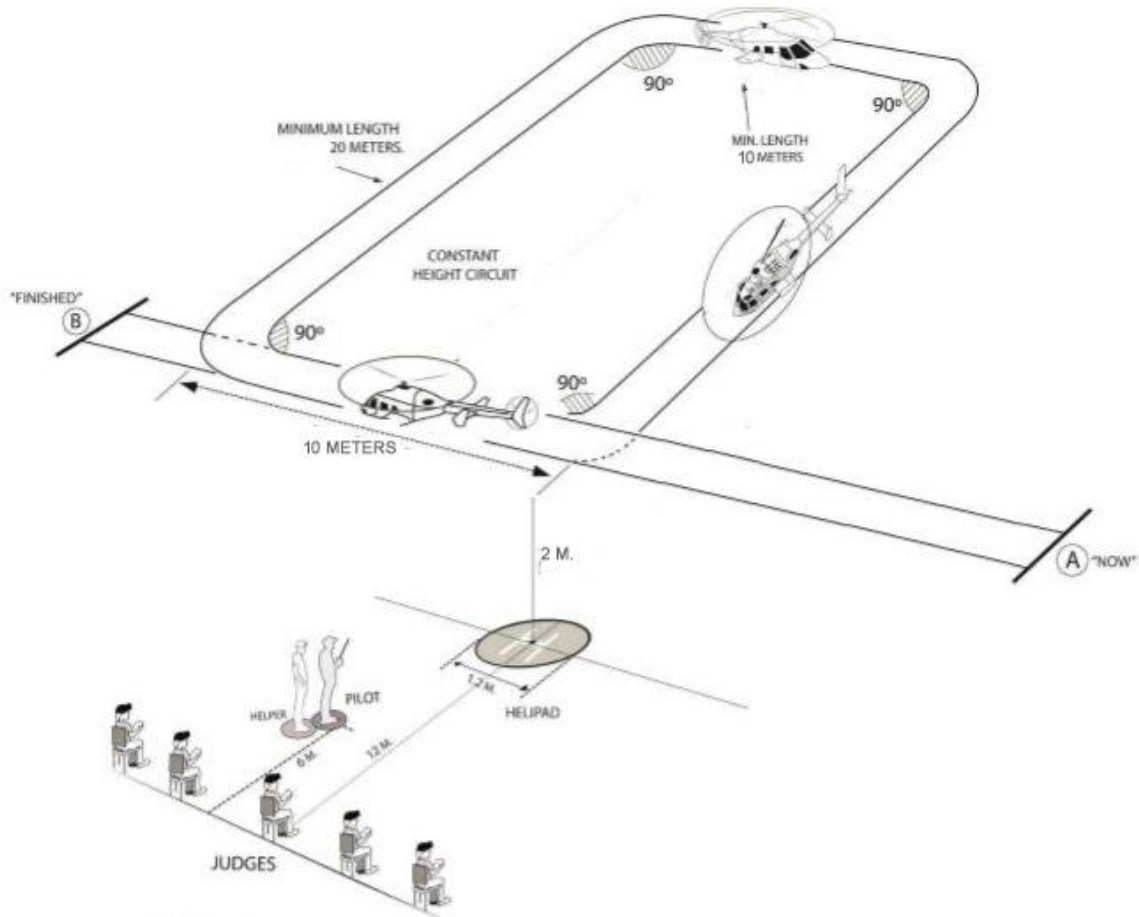

### ERRORS:

1. Not commenced and finished at points equidistant from the judges.
2. The model aircraft changes height.
3. Rate of turn at corners not constant or corners not 90°.
4. Legs are not straight.
5. Legs too long or too short.
6. The opposite sides of the rectangle are not of equal length.
7. Correction for drift not properly made.
8. Final leg of rectangle not centred on judges' position.
9. Start and finish tracks not the same.
10. Start and finish tracks not parallel with judges' line.
11. Model is too far away / too close / too high / too low.
12. Flight is not constant and smooth

NOTE: The manoeuvre must demonstrate a relationship between the straight legs of 2:1

**G 180° ASCENDING TURN**

The model aircraft approaches in straight and level flight on a line parallel with the judges' line. After passing the judges' position a smooth climbing turn is commenced away from the judges. At the apex of the turn, the model should track 90° to the entry track and the bank angle should be at least 60° for a non-aerobatic model and at least 90° for an aerobatic model. The height gain should be appropriate to the capability of the prototype. The model then continues on a mirror image of the entry flight path and recovers to straight and level flight at the same height but on the opposite heading to the entry and on a line displaced away from the judges. This manoeuvre can be done from the left or right side.

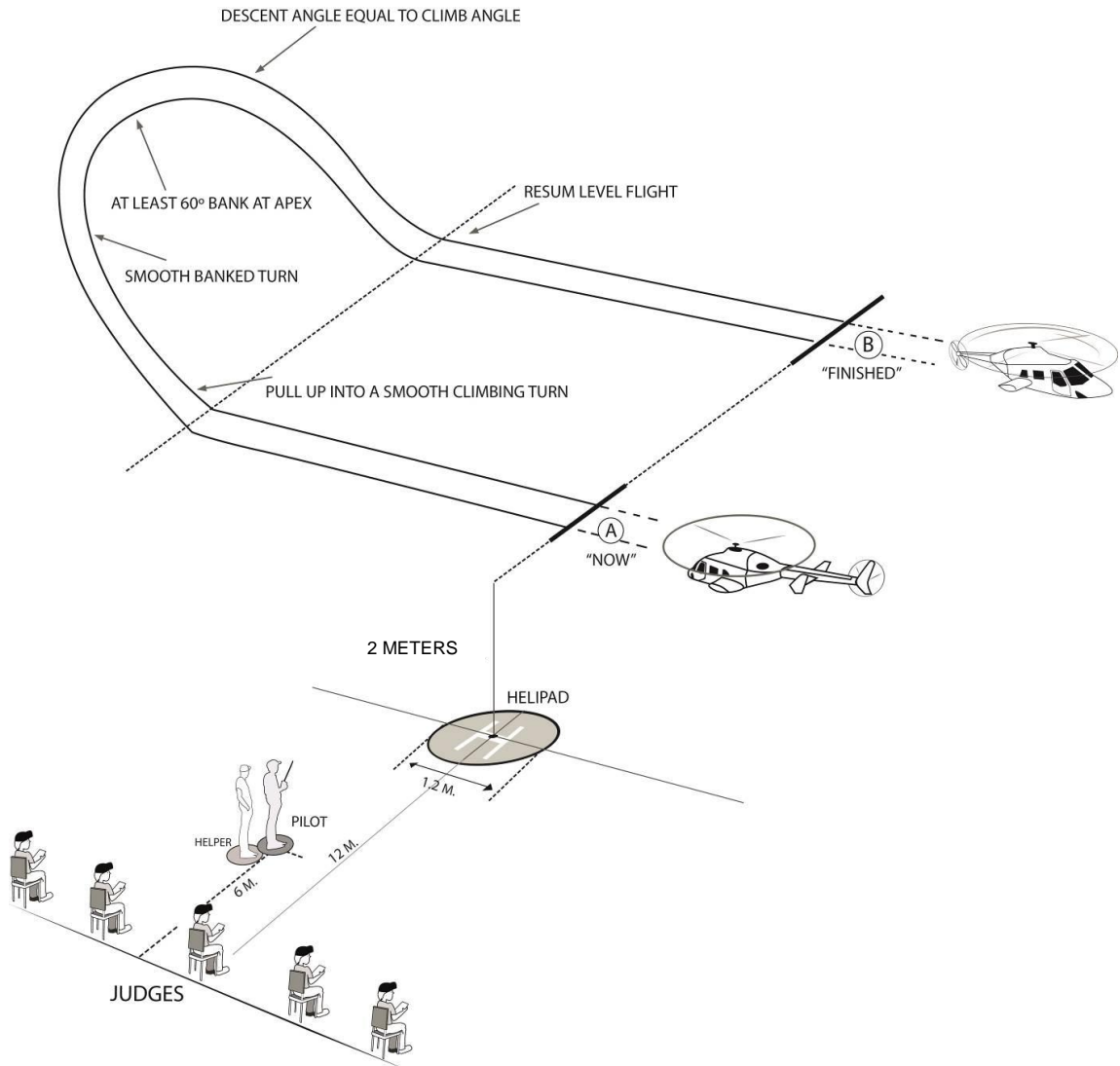
**ERRORS:**

1. Start and finish positions not as indicated.
2. Insufficient climb achieved.
3. Insufficient bank achieved.
4. Climb and descent angles not equal throughout manoeuvre.
5. Model aircraft does not fly a smooth and symmetrical arc.
6. Entry and exit paths not parallel with judges' line.
7. Overall size of manoeuvre not realistic for prototype.
8. Model aircraft flight path not smooth and steady.
9. Model is too far away / too close.



**H 360° DESCENDING CIRCLE**

Commencing from straight and level flight, the model aircraft performs a gentle 360° descending circle over the landing area, in a direction away from the judges, at a constant throttle setting. The manoeuvre terminates at a minimum at eye level, resuming straight and level flight on the same path. This manoeuvre can be done from the left or right side.

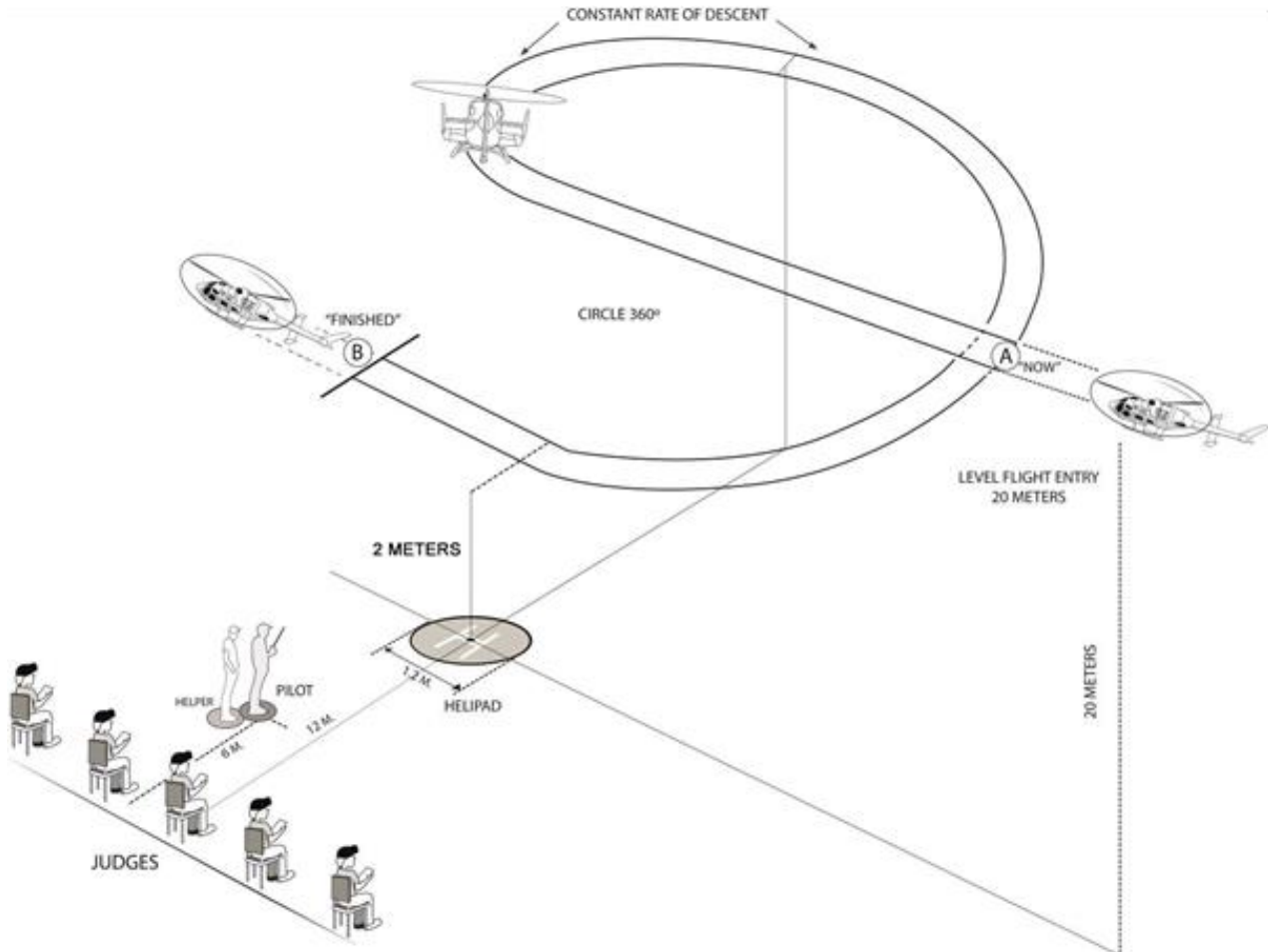
**ERRORS:**

1. Rate of descent not constant.
2. Descent too steep.
3. Throttle setting not constant or low enough.
4. Circle misshapen.
5. No significant loss of height.
6. Model aircraft does not descend to 6 metres or below.
7. Circle not centred on judges' position.
8. Entry and exit paths not parallel with the judges' line.
9. Start and finish not called in straight and level flight.
10. Model is too far away / too close.



## I LAZY EIGHT

The model aircraft approaches in straight and level flight on a line parallel with the judges' line. When the model aircraft is in line with the judges (the centre), a smooth curving climb is commenced which progresses to a smooth climbing turn of constant radius away from the judges. At the apex of the turn the bank should be at least  $25^{\circ}$  and the model aircraft shall be on a heading of  $90^{\circ}$  to the judges' line. The nose of the model aircraft then lowers and the bank comes off at the same rate as it went on. The turn is continued beyond  $180^{\circ}$  to intercept the centre with the wings level and at the same height as the entry height into the manoeuvre. At the centre, another smooth climbing turn, the shape of which should be the same as the first turn, is immediately commenced away from the judges. The second turn is then continued beyond  $180^{\circ}$  to cross the centre with the wings level and at the same height as the entry into the manoeuvre. The Lazy Eight is completed by maintaining this height and heading with wings level before turning to intercept the original approach track to exit the manoeuvre parallel to the judges' line in straight and level flight. The figure should be symmetrical each side of the judges' position.

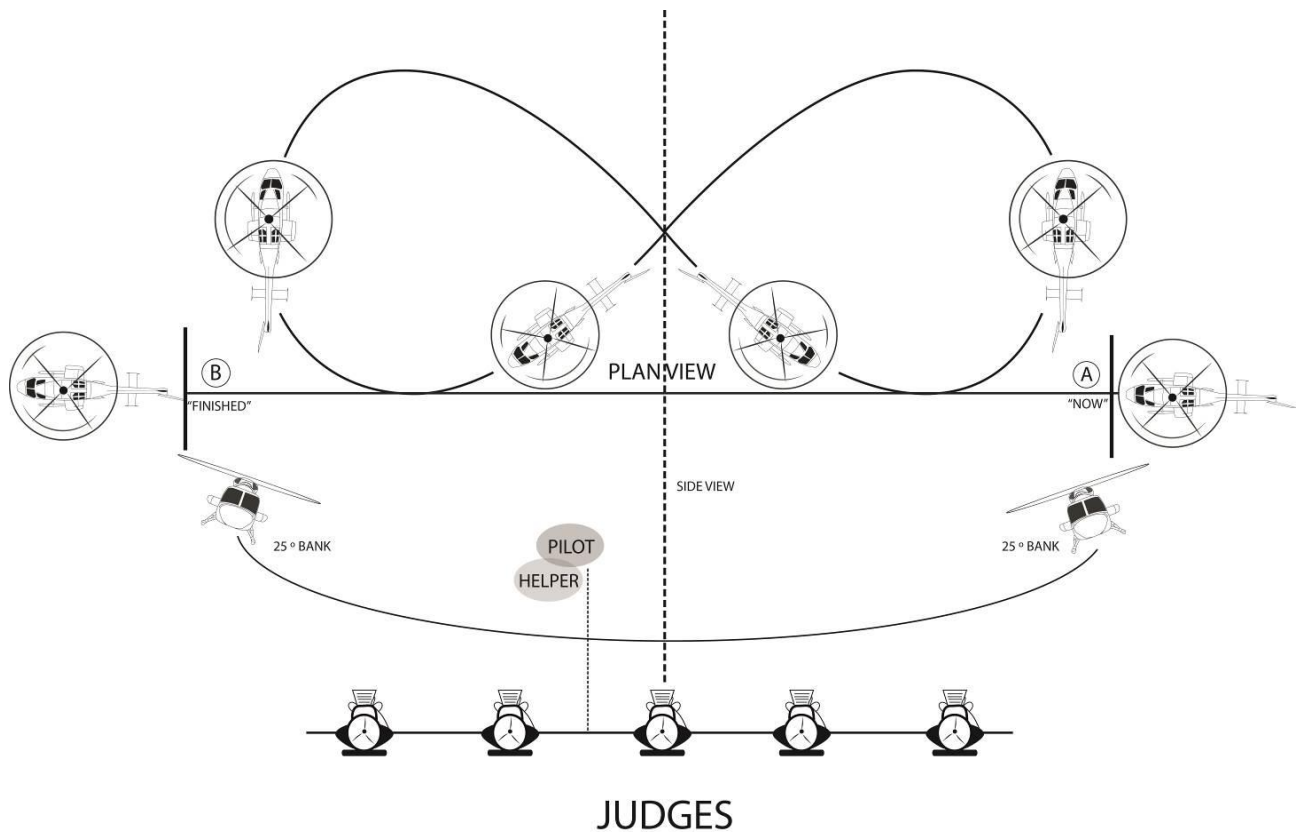

**View 2 of the figure**

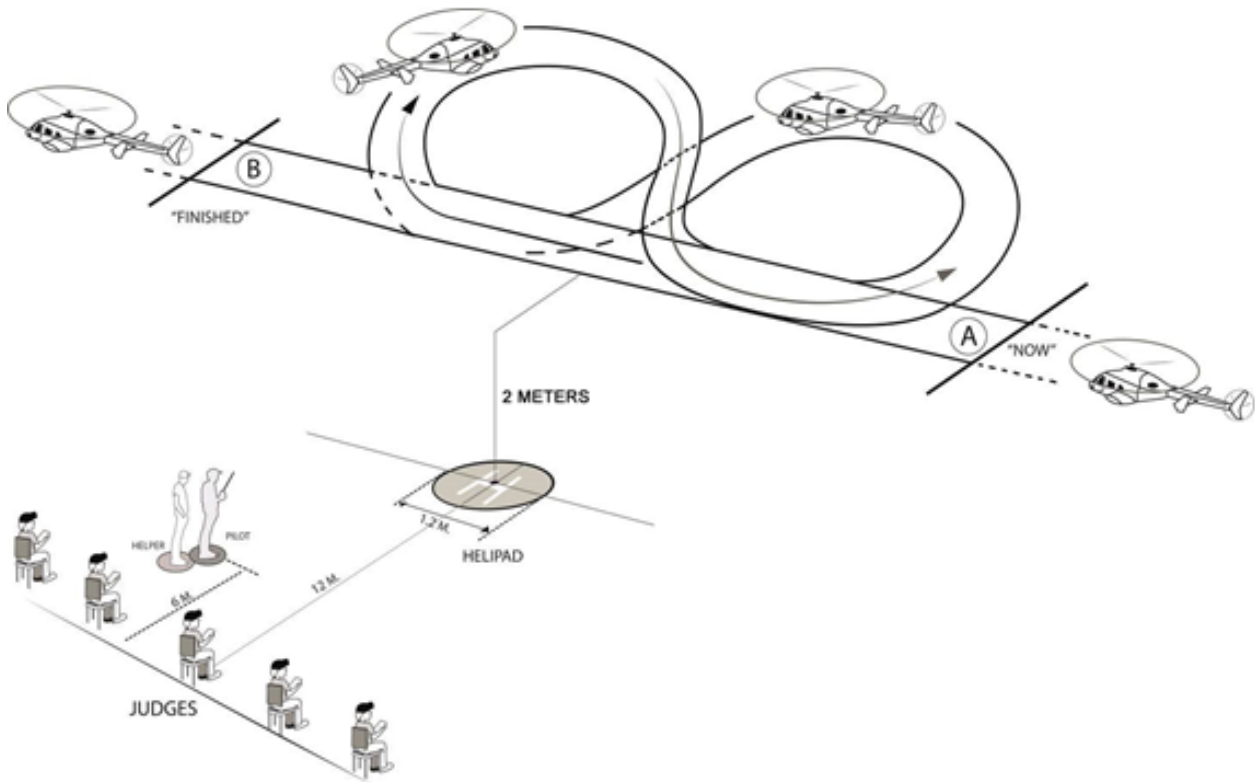

**ERRORS:**

1. Entry and exit paths not parallel with judges' line.
2. Insufficient climb achieved.
3. Insufficient bank achieved.
4. Climb and descent angles not equal throughout manoeuvre.
5. Manoeuvre not symmetrical about judges' position.
6. Arcs misshapen.
7. Start and finish positions not as indicated.
8. Overall size of manoeuvre not realistic for prototype.
9. Model aircraft flight path not smooth and steady.
10. Model is too far away / too close /too high / too low.

NOTE: The competitor will adjust the manoeuvre depending on whether it is done from the left or the right.

**J PROCEDURE 90° WITH STRAIGHT FLIGHT AND 180° ANGLE**

The model aircraft approaches in straight and level flight on a line parallel with the judges' line. When the model aircraft is in line with the centre of the judges' line, the model makes a 90° turn opposite to the judges' line, followed by 20 metres of straight and level flight. Then the model makes a 180° arc, performing this arc with the tail rotor to the outside, and continuing this arc to the intersection with the entry track. This manoeuvre can be done from the left or right side.

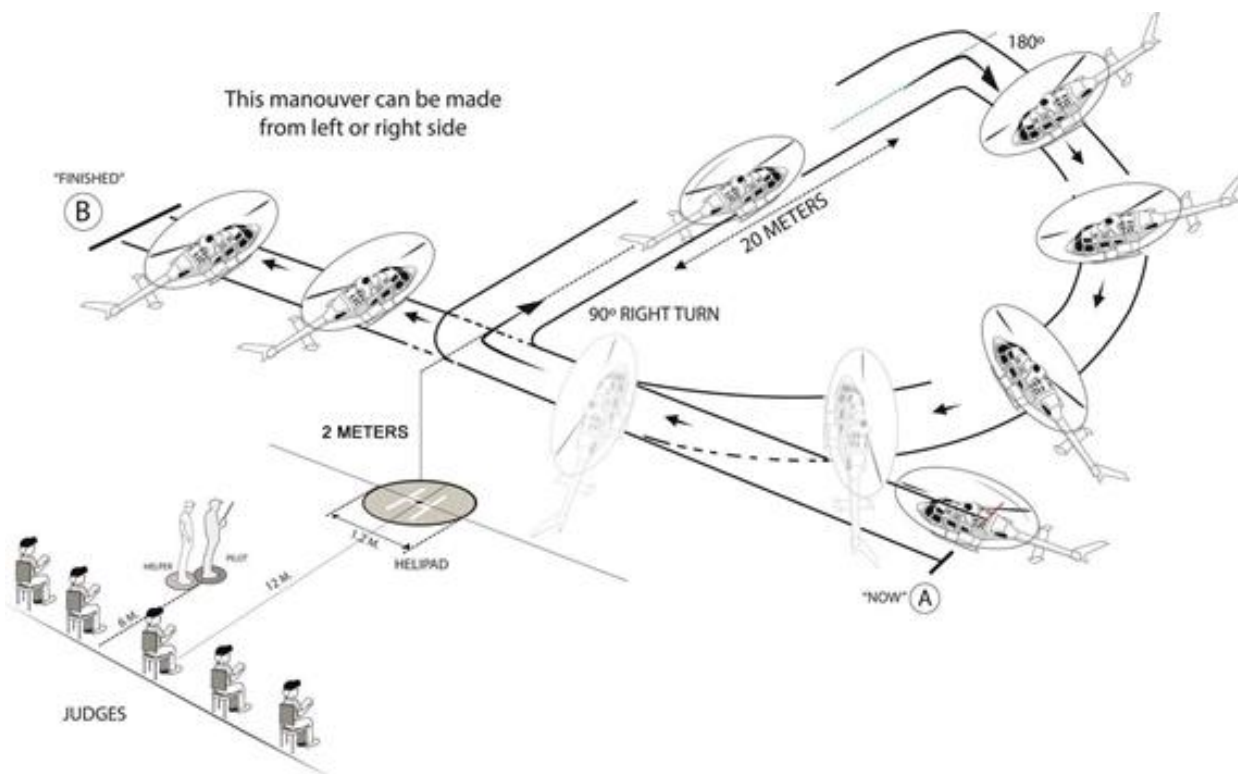
**ERRORS:**

1. The model is too far / too close / too high / too low.
2. The model does not maintain a constant height.
3. The model does not perform the manoeuvre at eye level.
4. The 90° and 180° turns are not constant.
5. The flight line of the model is not smooth and constant.
6. The 20 metre track is not straight.

**K ONE LOOP**

From straight flight at 6 metres high at maximum, the model aircraft pulls up into an inside loop and resumes straight and level flight on the same heading as the entry. The model may adjust the speed and size of the manoeuvre depending on the prototype flight performance. This manoeuvre can be made from the left or right side.

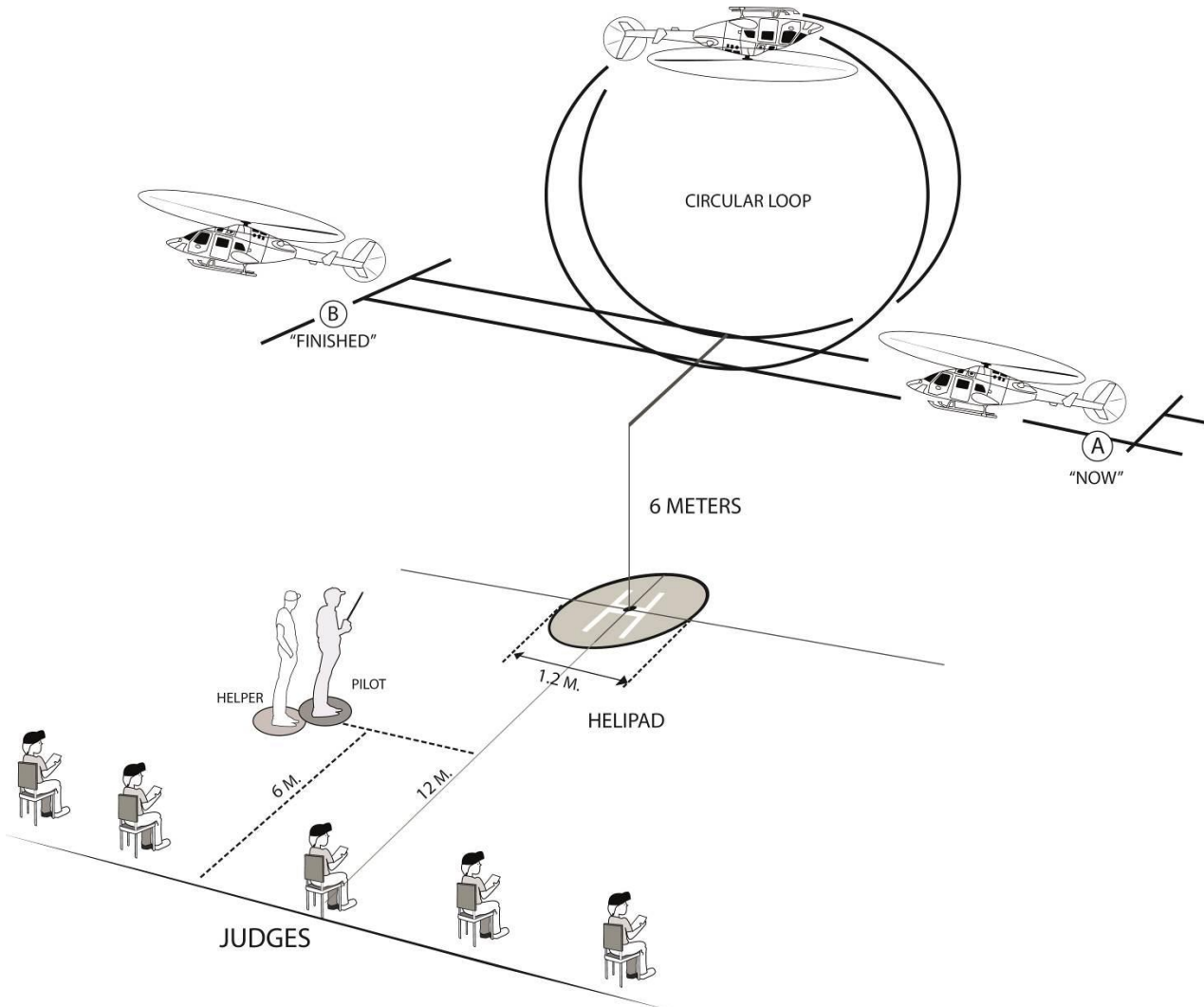
**ERRORS:**

1. Track of loop not vertical.
2. Loop not sufficiently circular, commensurate with the subject type.
3. Size and speed of loop not in manner of prototype.
4. Not centred on judges' position.
5. Does not resume straight and level flight on same track and height as entry.
6. Manoeuvre not flown parallel with judges' line.
7. Model is too far away / too close / too high / too low.

**L INVERTED FLIGHT**

From straight and level flight at 8 metres high, the model aircraft makes a half roll into inverted attitude and makes a straight inverted flight of 20 metres in length, then makes another half roll out of inverted attitude and resumes normal straight flight. This manoeuvre can be made from the left or right side

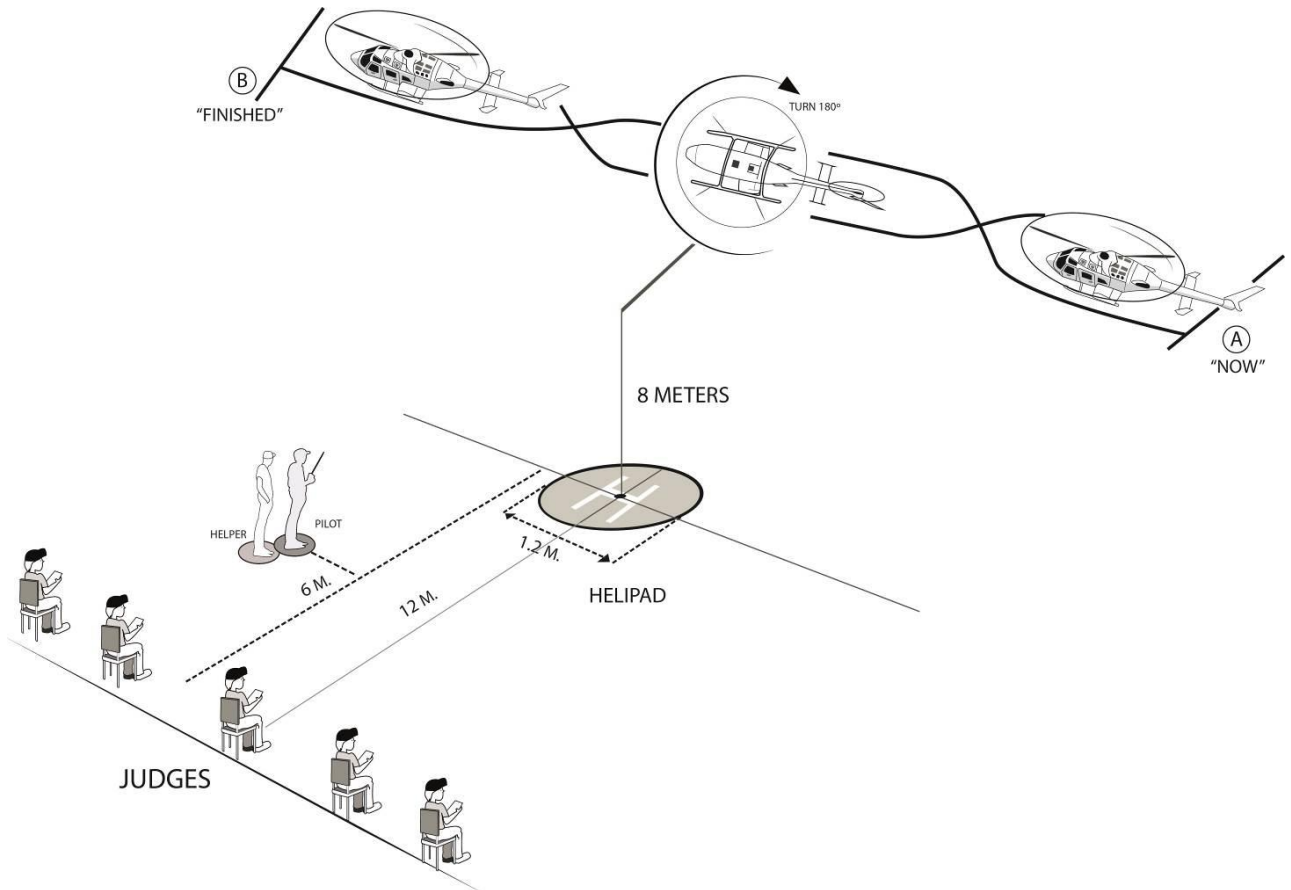
**ERRORS:**

1. Rate of roll is not constant.
2. The model aircraft changes altitude during the manoeuvre.
3. The model aircraft does not resume straight and level flight on the correct heading.
4. The manoeuvre is too small or too large in reference to the prototype and scale of the model aircraft.
5. The model is too far/ too close / too high / too low.

**M FIGURE BACKWARD**

The model starts the manoeuvre at one metre high over the centre of the helipad (from Point A) then ascends in a smooth angle from 30° to 50°. The manoeuvre will finish with a 5 second hover at Point B at a minimum height of 8 metres. This manoeuvre can be made to the left or right side.

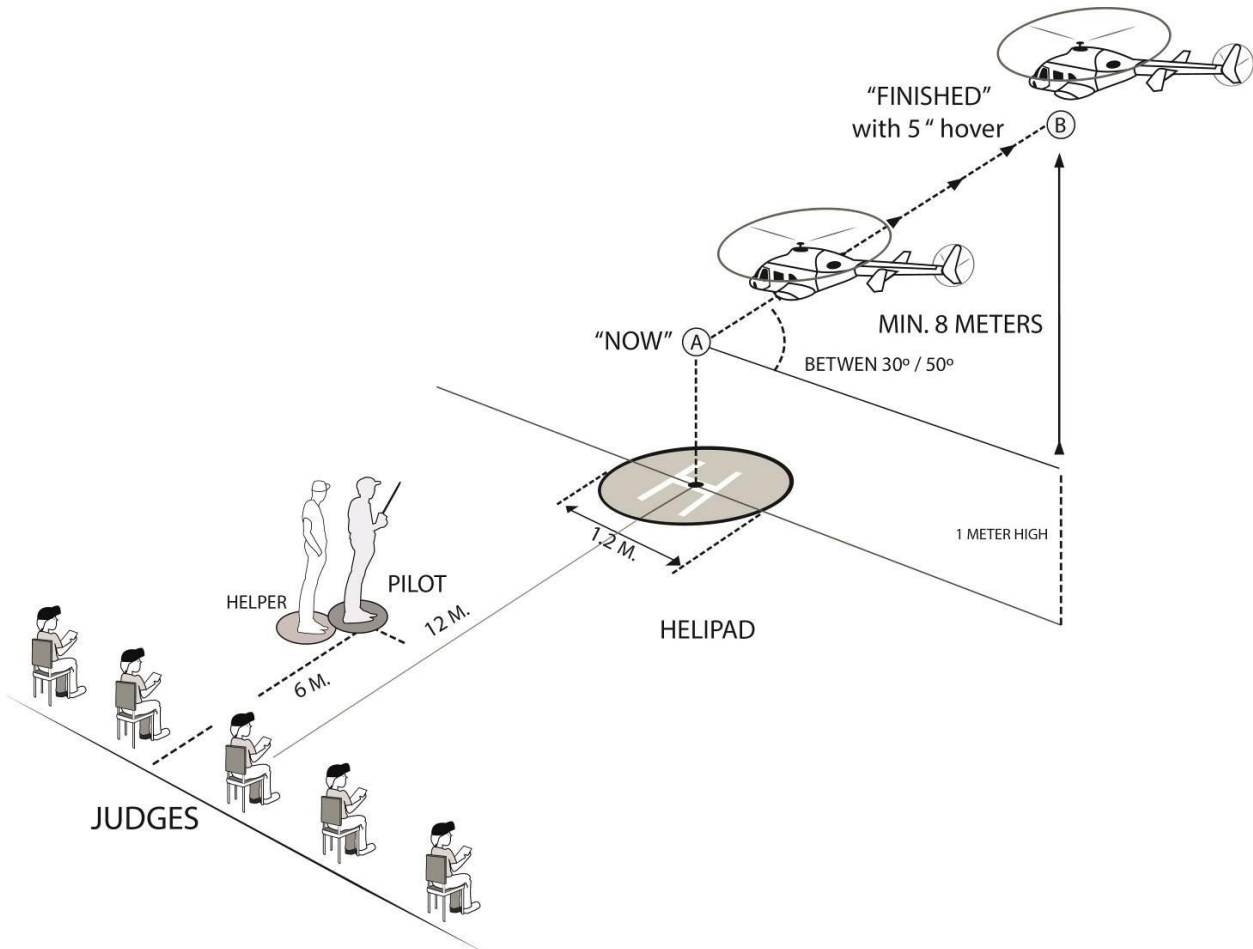
**ERRORS:**

1. Manoeuvre is finished too low.
2. The ascending angle is not between 30° and 50°.
3. The climb is not smooth, continuous and steady.
4. The model is too far / too close / too high / too low.